

# Instruction Manual

CarPlay Integration for Volkswagen MIB2 System

<b>Model No.</b>	<b>VI-VW-343C</b>
<b>MB-SW Ver.</b>	0A0A00
<b>CP-SW Ver.</b>	C7.3
<b>Manual Ver.</b>	1.0
<b>Date</b>	Jan.28.2019



## Content:

● <b>Warning</b>	<b>3</b>
● <b>Compatibility</b>	<b>5</b>
● <b>Features</b>	<b>6</b>
● <b>Package Components</b>	<b>7</b>
● <b>Connection Diagram</b>	<b>8</b>
● <b>DIP Setting</b>	<b>10</b>
● <b>Operation Instruction</b>	<b>11</b>
■ <b>How to switch from original to add-on interface</b>	<b>11</b>
■ <b>Apple CarPlay</b>	<b>12</b>
■ <b>Android Auto</b>	<b>13</b>
■ <b>Mirroring</b>	<b>14</b>
■ <b>USB Multimedia Playback</b>	<b>14</b>



## Warning:

- In order to protect the driving safety and avoid break the traffic law; please DO NOT operate the interface while driving.
- The reversing surveillance function just is used in reversing assistance. Please check the entire surroundings while reversing.
- All steps of installation should be done by the well-trained specialist.
- During installation, the ignition key should be taken off and after all installation finished, connect power cable last.
- Please DO NOT plug or pull the connected cables in the state of power-on, in order to avoid damaged monitor or accessory.
- Install wiring in a manner in which cables will not come in contact with metal parts. The wiring may be damaged by contact with metal parts, resulting in fire and shocks. Avoid all contact with hot surfaces when wiring the main unit. High temperatures may damage wiring, causing shorts, arcing and fires.
- Please DO NOT put the product in the damp environment or water, in order to avoid electric shock, damaged and fire accident caused by a short circuit.
- Kindly check all components are in the box when receiving the product. If anything missing, inform to the supplier/manufacturer.
- Start the engine before loading, check the interface whether have function displayed, key control whether correct, the vehicle



---

interface whether having a scratch. Please give the feedback to the supplier/manufacturer if there have any questions.

- Please note that put the disassembled automotive components in a good way on the installation process, avoid scratching the instrument panel, the leftovers of connecting cables need to handle and DO NOT leave it in the car. The connecting plug must be insulated in order to short circuit.
- The cables should be connected in a good way, the vehicle installation space is a little small, so reduce space usage as far as possible. There should be a good plan about connect cables, avoid affecting the active component of connecting, such as control components of turning the steering wheel, throttle and brake pedal. There need to be fastened after connecting cables in case of a drop.



## Compatibility:

Brands	Models	Years	Original System
<p>Volkswagen</p>	<p>Golf, Passat, Polo, Tiguan, Magotan, Jetta, Beetle, Fox, etc.</p>	<p>2016 -</p>	<p>MIB II system with 5.8"/6.5"/8" OEM screen and CD player in the glove compartment</p> 

**NOTE!** This interface DO NOT available for 9.2 inch OEM radio yet.



## Features:

- Integrated 3 in 1 module supports Apple CarPlay, Android Auto, and screen mirroring functions
- Support USB HD video and lossless music playback (APE, WAV, FLAC, MP3, WMA, etc.)
- Offers 2 CVBS video in for front/rear view camera
- Support PDC (Parking Distance Control) and FPG (Flexible Parking Guidelines)
- Supply 12V power to the backup camera
- 2 alternative ways display front view (DIP setting): display automatically when shifted from “R” gear or click “DVR” icon
- VGA input for specific 360 panoramic system, offers a clearer picture
- Operate by OEM buttons & touch screen
- Support further software update by TF card

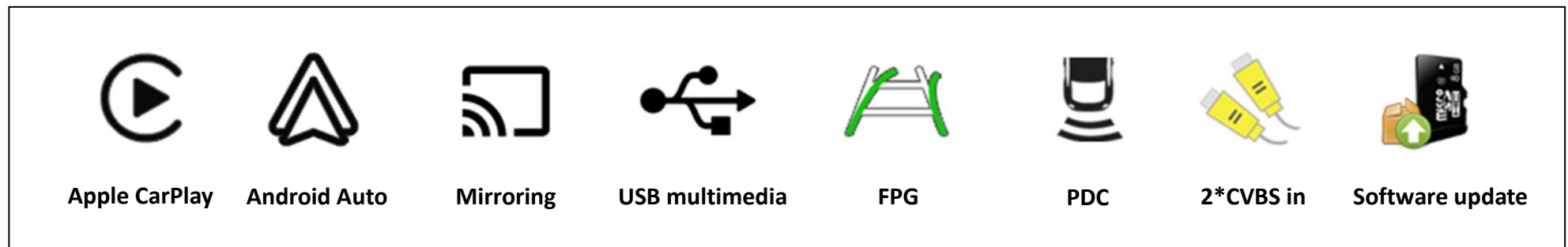



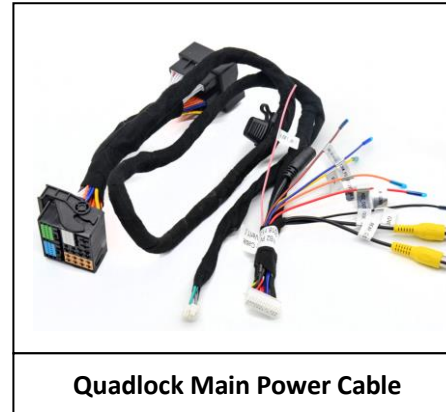

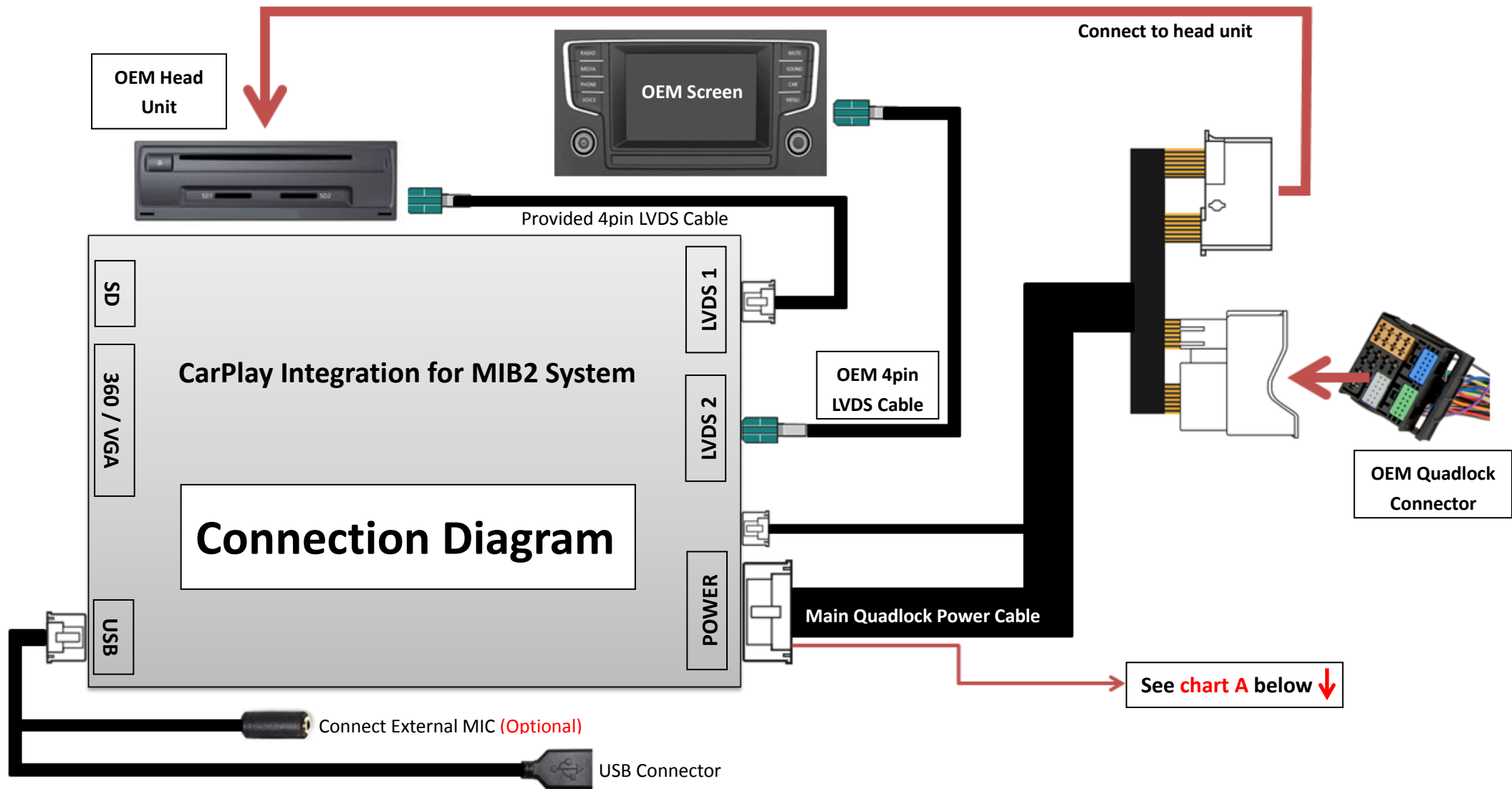





# Package Components:







**Chart A:** ↓

 <b>ACC_OUT</b>	Supply power for DVR or other video devices. Just connect the <b>ACC_OUT (RED)</b> when use aftermarket front view camera
 <b>B+</b>	
 <b>GND</b>	Connect <b>GND</b> if there is any audio noise
 <b>A_GND</b>	
 <b>LEFT_DET</b>	N/A
 <b>RIGHT_DET</b>	N/A
 <b>CAM_POWER</b>	Supply 12V power for backup camera
 <b>REVERSE</b>	Reverse detect (Connect to reverse light if <b>CAM_POWER</b> cable does not output 12V)
 <b>REAR_CVBS</b>	Rear view camera video input
 <b>FRONT_CVBS</b>	Front view camera/DVR video input
 <b>AUDIO OUT</b>	AUX audio output (Connect to external audio adapter kits for sound delivering to car radio if there is not OEM AUX function)



# DIP Setting:



PIN	ON ↓	OFF ↑
1	Reserved	Reserved
2	Disable 360 Panoramic	Enable 360 Panoramic
3	CVBS	VGA (360 mode)
4	Display front view camera for 10S automatically after shifted from "R" gear	Skip front view camera (Click "DVR" icon to display front view/DVR)
5	Selection of car model	
6		
7	Original Rear View Camera	Aftermarket Rear View Camera
8	External Microphone	Original Microphone

5	6	Car Models
OFF	OFF	6.5"/8"
ON	OFF	5.8"
ON	ON	Reserved
OFF	ON	Reserved

**NOTE!** Please reboot the interface for effective after changing any DIP setting.



# Operation Instruction:

## ● How to switch from Original to Add-on interface

Long press "Media"



Order: OEM - Add on - OEM

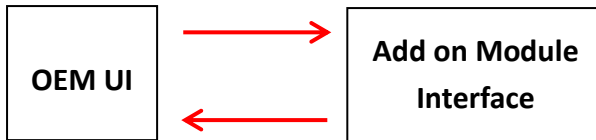

It will switch to add on module UI automatically when a phone/USB stick connected.

How to delivering audio to OEM radio

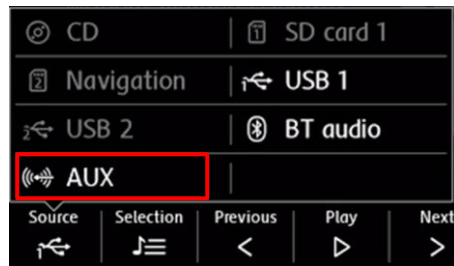

**NOTE!** Make sure switch to "AUX" mode on original car stereo for audio transmission before using the CarPlay integration.

## Add on module UI:

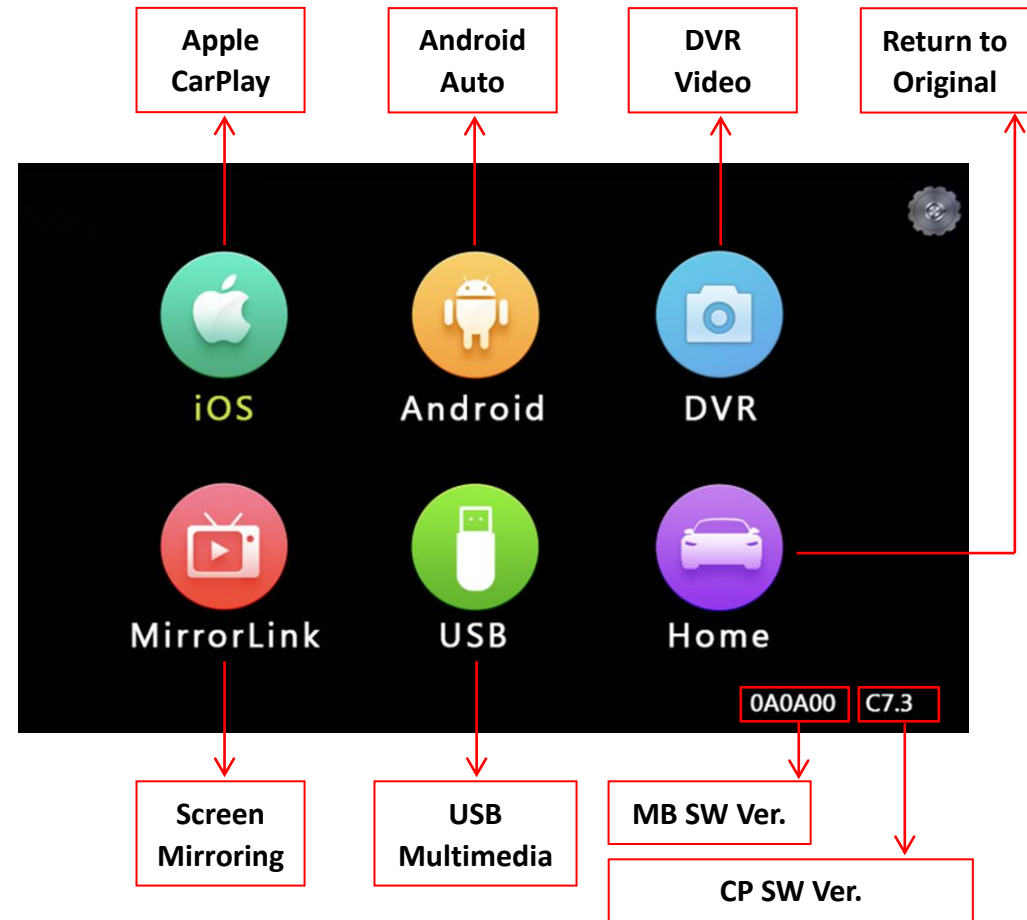

• **Apple CarPlay**

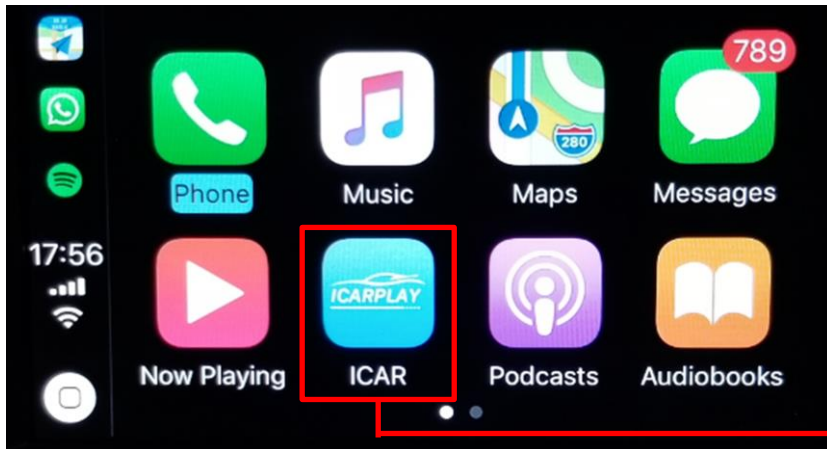

Return to add-on module UI

Touch to control all functions of Apple CarPlay

**NOTE!** Please **disconnect** the Bluetooth connection between the phone and car stereo when using Apple CarPlay.

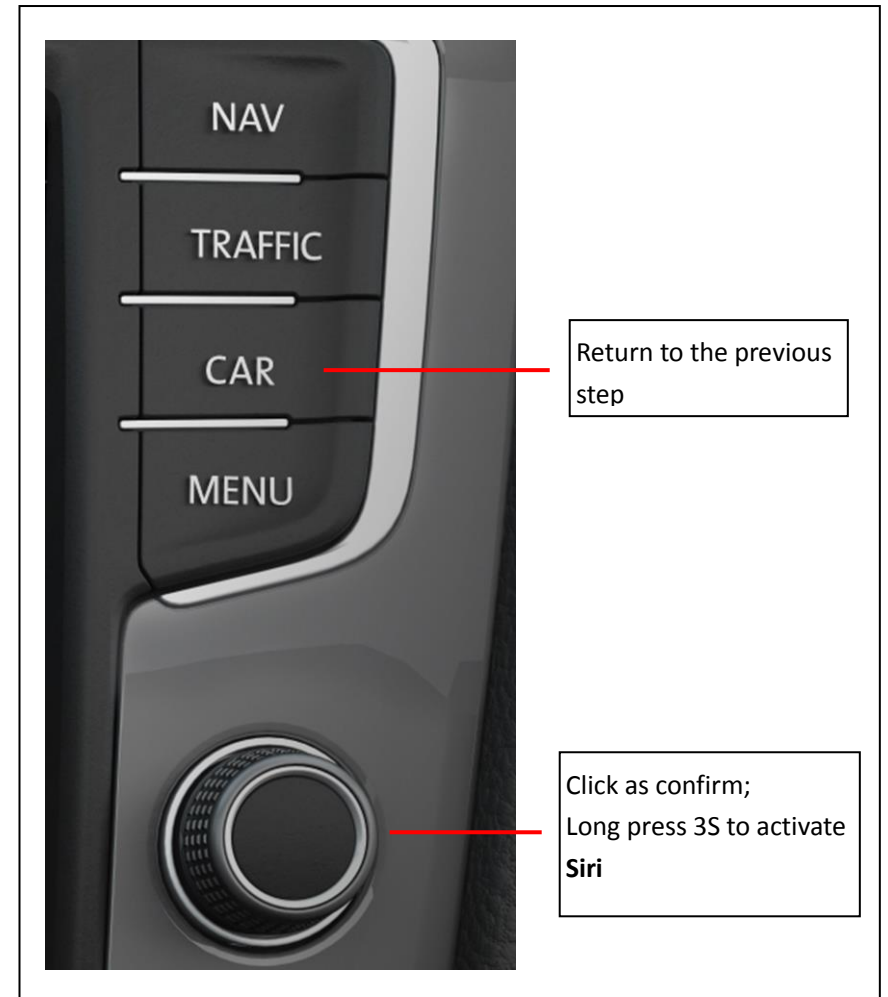

Return to the previous step

Click as confirm;  
Long press 3S to activate Siri



● **Android Auto**

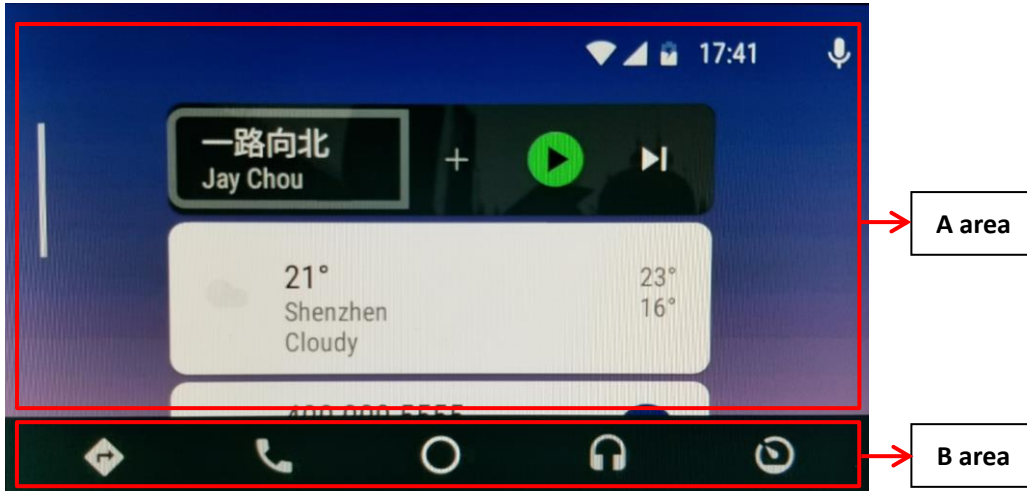

**Touch to control all functions of Android Auto**

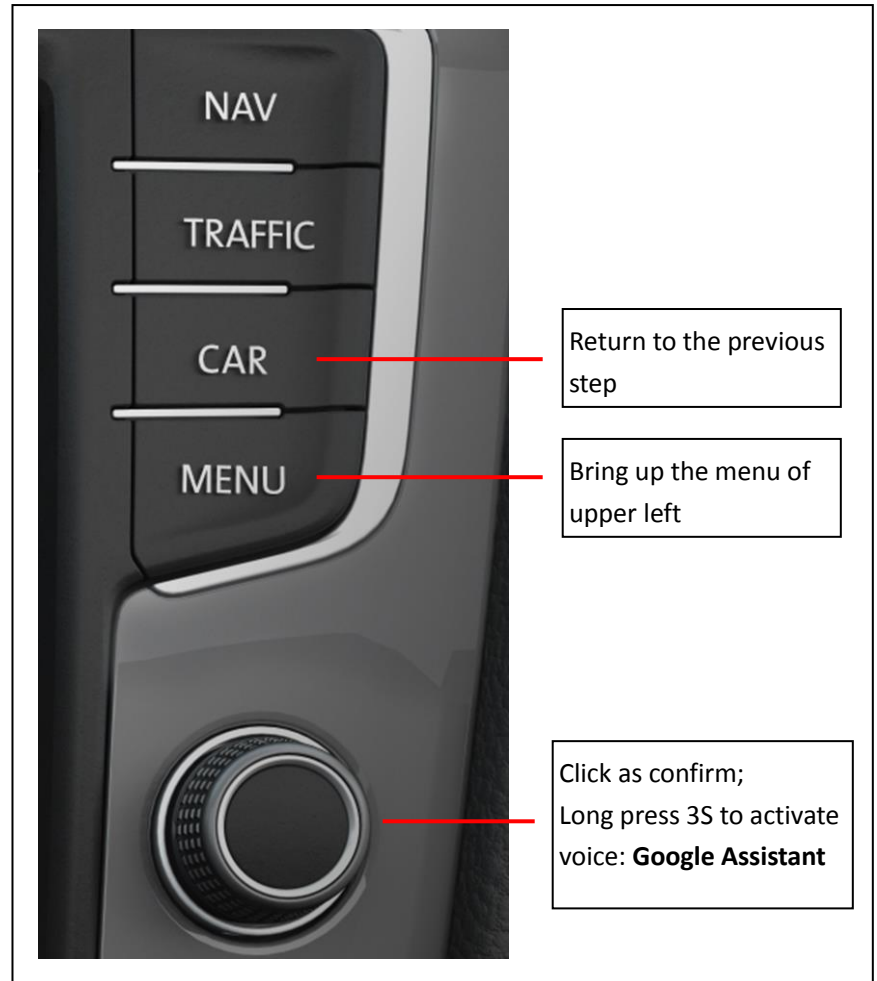

**NOTE!**

Make sure smartphone connect to original car stereo Bluetooth (Only tick **CALL AUDIO**, uncheck **MEDIA AUDIO**) for phone call audio delivering when using Android Auto.

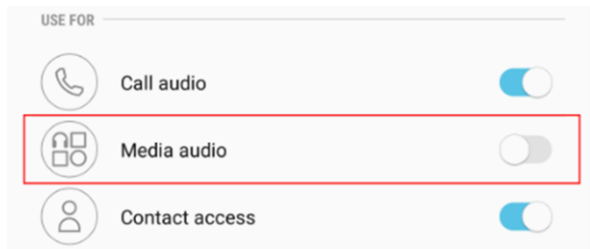

● **Mirroring**



Connect Android smartphone/iPhone with USB cable, and then enter "MirrorLink" for screen mirroring.

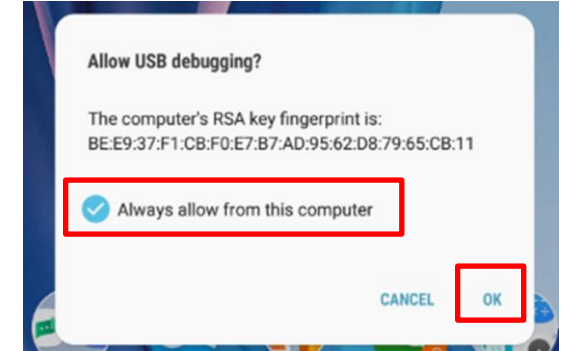
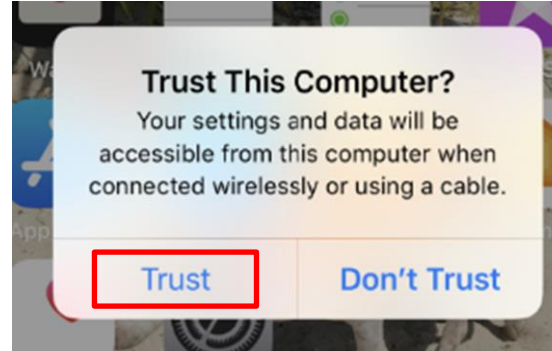

**NOTE!**

- Please always **trust or allow** when display a popup notification
- Enabling "USB Debugging" on an Android device
- Android device must connect to car stereo BT for all audio delivering

● **USB Multimedia Playback**



Connect a USB memory stick, enter "USB" icon for playing multimedia: Music, Picture, and Video.





Copyright © Cartizan. All rights reserved.

