



INSTALLATION INSTRUCTIONS FOR PARTS 95-6511 or 99-6511

APPLICATIONS

See application list inside

Chrysler multi-kit 2007-up 95-6511 or 99-6511

KIT FEATURES

95-6511:

- Double DIN radio provision
- Stacked ISO radio provision

99-6511:

- DIN radio provision with pocket
- ISO radio provision with pocket



KIT COMPONENTS

95-6511: • A1) Double DIN brackets/trim plate

99-6511: • A2) Radio housing with pocket • B2) ISO brackets • C2) ISO trim plate

A1

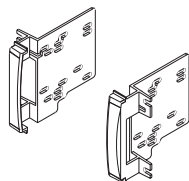

A2

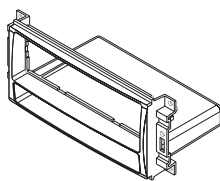

B2

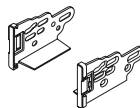

C2

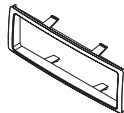

WIRING & ANTENNA CONNECTIONS (sold separately)

Wiring Harness:

- XSVI-6522-NAV Chrysler CAN RAP harness 2007-up
- CHTO-03 Chrysler CAN amp harness 2007-up

Antenna Adapter:

- 40-EU10 European antenna adapter 2002-up

TOOLS REQUIRED

- Panel removal tool • Phillips screwdriver
- Small flat blade screwdriver • Socket set
- Cutting tool (*sub-dash modifications required for most 95-6511 double DIN applications*)

CAUTION: Metra recommends disconnecting the negative battery terminal before beginning any installation. All accessories, switches, and especially air bag indicator lights must be plugged in before reconnecting the battery or cycling the ignition.

NOTE: Refer to the instructions included with the aftermarket radio.



95-6511 or 99-6511

Applications

Chrysler	Commander 2008-2010
200 2011-2013	Grand Cherokee 2008-2010
300/300C 2008-2010	Patriot 2009-up
Aspen 2008-2009	Liberty 2008-2012
Sebring 2007-2010	Wrangler** 2007-up
Town and Country..... 2008-up	
Dodge	Mitsubishi
Avenger 2007-up	Raider 2008-2009
Caliber 2009-2012	
Challenger 2008-up	Ram
Charger 2008-2010	1500.....2012
Dakota 2008-2011	2500/3500 2012-up
Durango 2008-2009	Chassis Cab 2012-up
Grand Caravan 2008-up	C/V Tradesman 2012-up
Journey** 2009-2010	
Magnum 2008-2009	VW
Nitro 2007-2011	Routan 2009-2012
Ram 1500.....2009-2011	
Ram 2500/3500 2010-2011	
Jeep	
Compass 2009-up	

*** (modifications to radio cavity required)*

Table of Contents

Dash Disassembly	– Dodge Ram Chassis Cab 2011 9-10
– Chrysler Aspen 2008-2009/ Dodge Durango 2008-2009 3	– Jeep Compass 2009-up 8
– Chrysler Sebring 2007-2010 3	– Jeep Patriot 2009-up 8
– Chrysler Town and Country 2008-2010 4	– Jeep Commander/ Grand Cherokee 2008-2010..... 11
– Chrysler Town and Country 2011-up 5	– Jeep Wrangler 2007-2010** 12
– Chrysler 200 2011-2013..... 5	– Jeep Wrangler 2011-up** 12-13
– Chrysler 300/300c 2008-2010..... 6	– Mitsubishi Raider 2008-2009..... 12
– Dodge Avenger 2008-up 6	– Ram 1500 2012..... 9-10
– Dodge Caliber 2009-2012..... 8	– Ram 2500/3500 2012-up 9-10
– Dodge Challenger 2008-up 8	– Ram Chassis Cab 2012-up..... 9-10
– Dodge Charger 2008-2010 6	– Ram C/V Tradesman 2012-up 10
– Dodge Dakota 2008-2011..... 7	– VW Routan 2009-up..... 5
– Dodge Grand Caravan 2008-2010..... 4	
– Dodge Grand Caravan 2011-up..... 5	Kit Assembly
– Dodge Journey 2009-2010** 8	– Double DIN radio provision 13
– Dodge Magnum 2008-2009..... 6	– Stacked ISO radio provision..... 13
– Dodge Nitro 2007-2011/ Jeep Liberty 2008-2012 7	– DIN radio provision with pocket..... 14
– Dodge Ram 1500 2009-2011 9-10	– ISO radio provision with pocket..... 14
– Dodge Ram 2500/3500 2010-2011 9-10	

*** (modifications to radio cavity required)*

Chrysler Aspen 2008-2009 Dodge Durango 2008-2009

1. Unsnap and remove storage cup holder assembly. (Figure A)
2. Remove (2) screws from bottom edge of center dash trim panel. Unsnap and remove the panel. (Figure B)
3. Remove (4) screws securing the radio. Unplug and remove radio. (Figure C)

Continue to kit assembly

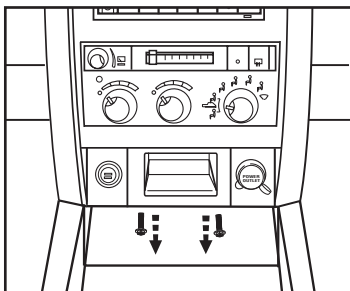

(Figure B)

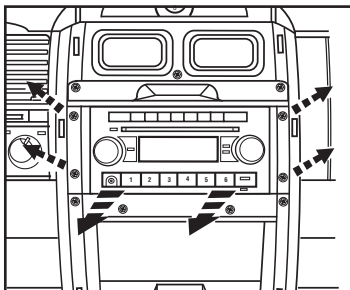

(Figure C)

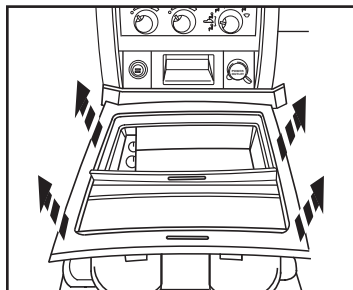

(Figure A)

Chrysler Sebring 2007-2010

1. Unclip entire panel surrounding radio including A/C vents and clock. Unplug and remove panel. (Figure A)
2. Remove (4) 7mm screws securing radio. Unplug and remove radio. (Figure B)

Continue to kit assembly

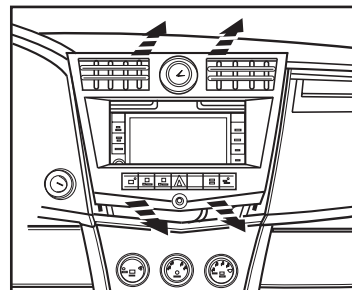

(Figure A)

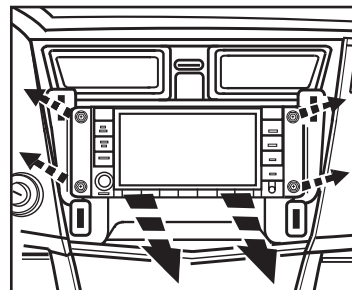

(Figure B)

Chrysler Town and Country 2008-2010 Dodge Grand Caravan 2008-2010

1. Remove (2) screw covers facing up above radio then remove the (2) Phillips screws exposed. (Figure A)
2. Lift up on panel above radio then remove (2) Phillips screws exposed at front edge of radio trim panel. (Figure B)
3. Remove (3) plastic push pins per side of bottom trim panel then slide panel toward rear of van to access (2) screws on bottom of radio trim panel. (Figure C)

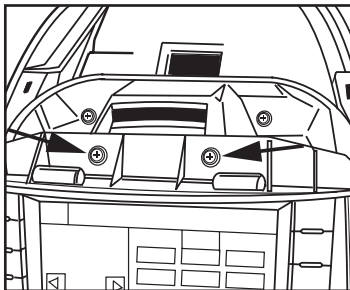

(Figure B)

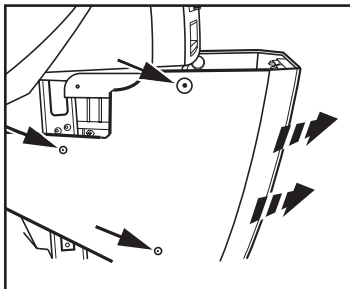

(Figure C)

4. Remove (2) Phillips screws exposed at bottom edge radio trim panel. (Figure D)
5. Unclip and remove entire panel surrounding radio including climate controls, vents and clock. (Figure E)
6. Remove (4) Phillips screws securing radio. (Figure F)

Continue to kit assembly

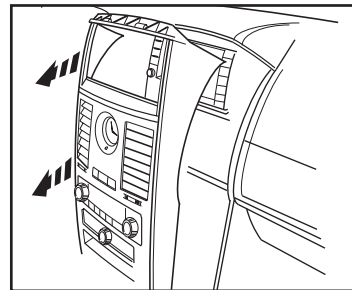

(Figure E)

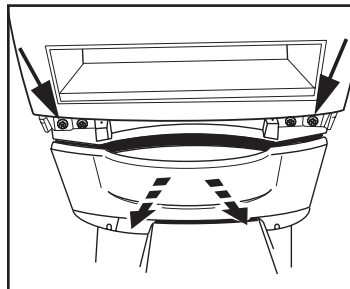

(Figure D)

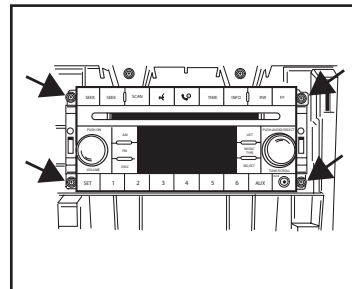

(Figure F)

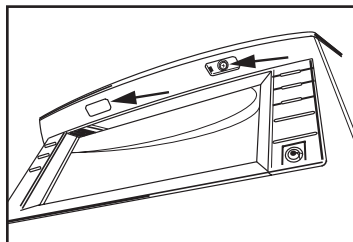

(Figure A)

Chrysler Town and Country 2011-up Dodge Grand Caravan 2011-up Volkswagen Routan 2009-up

1. Unclip and remove the radio trim panel. (Figure A)
2. Remove (4) Torx securing the radio. (Figure B)

Continue to kit assembly

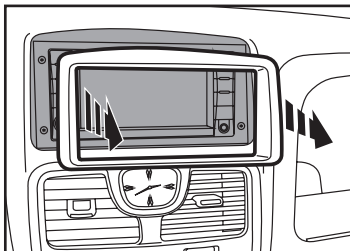

(Figure A)

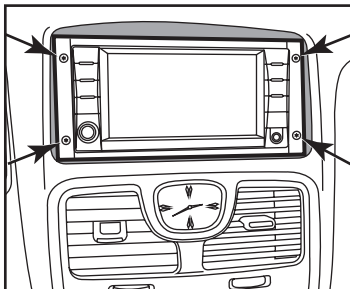

(Figure B)

Chrysler 200 2011-2013

1. Unclip and remove the radio trim panel. (Figure A)
2. Remove (4) Torx securing the radio. (Figure B)

Continue to kit assembly

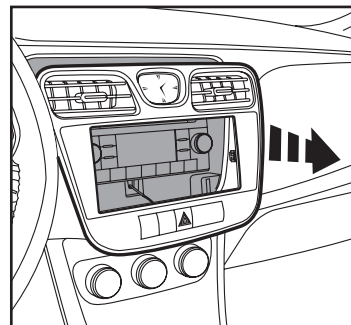

(Figure A)

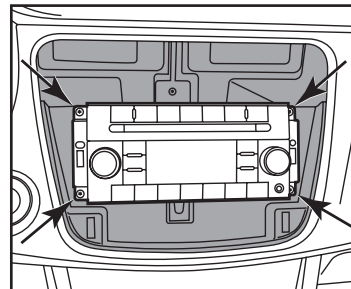

(Figure B)

Chrysler 300/300C 2008-2010, Dodge Magnum 2008-2009/Charger 2008-2010

1. Unsnap and remove center dash trim panel. (Figure A)
2. Remove (4) screws securing the radio. Disconnect and remove the radio. (Figure B)

Continue to kit assembly

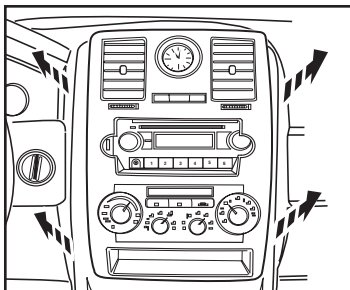

(Figure A)

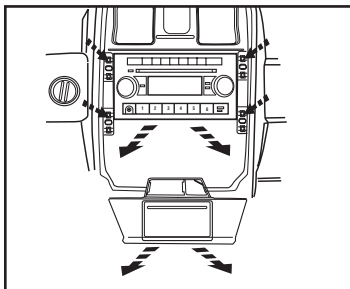

(Figure B)

Dodge Avenger 2008-up

1. Unclip and remove the center console trim panel. (Figure A)
2. Unclip the center dash trim panel. (Figure B)
3. Remove (4) screws securing the radio. Disconnect and remove the radio. (Figure C)
4. Remove (3) screws securing the radio rear support bracket and remove the bracket. (Figure D)

Continue to kit assembly

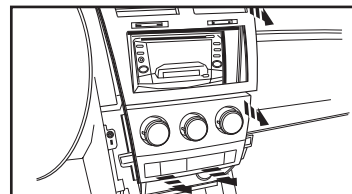

(Figure B)

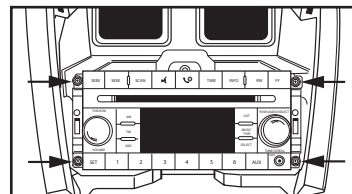

(Figure C)

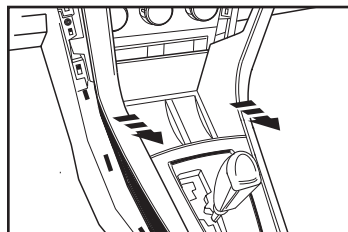

(Figure A)

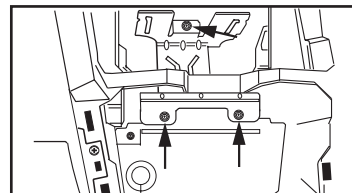

(Figure D)

Dodge Dakota 2008-2011

1. Unclip and remove the trim panel surrounding the radio. (Figure A)
2. Remove (4) Phillips screws securing the radio. (Figure B)

Continue to kit assembly

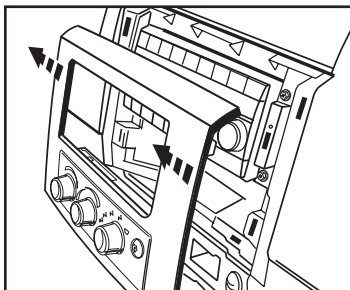

(Figure A)

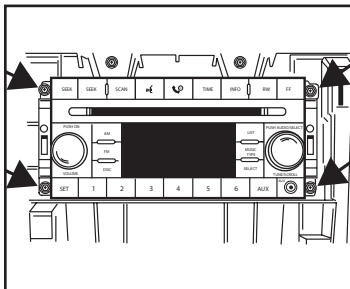

(Figure B)

Dodge Nitro 2007-2011 Jeep Liberty 2008-2012

1. Unclip entire panel surrounding radio and climate controls, including A/C vents. Unplug and remove panel. (Figure A)
2. Remove (4) 7mm screws securing radio. Unplug and remove radio. (Figure B)

Continue to kit assembly

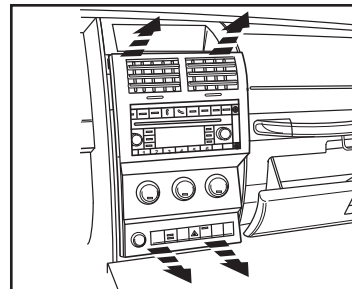

(Figure A)

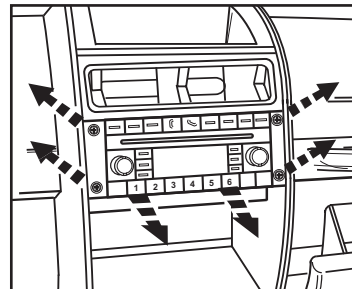

(Figure B)

Dodge Journey 2009-2010

(modifications to radio cavity required)

1. Unclip and remove the entire factory radio trim panel including the A/C controls. (Figure A)

TIP: Open the compartment door at the top of the radio trim panel.

2. Remove (4) 7mm screws securing radio to dash to remove. (Figure B)

NOTE: The top of the metal bracket in the sub dash will need to be cut to allow for the clearance of the Double DIN radio's chassis. (Figure C)

Continue to kit assembly

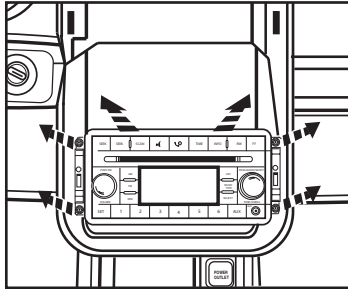

(Figure B)

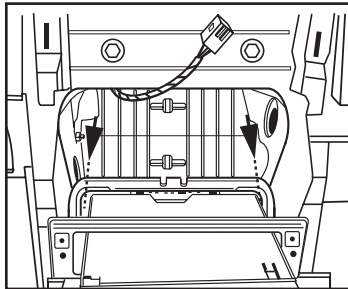

(Figure C)

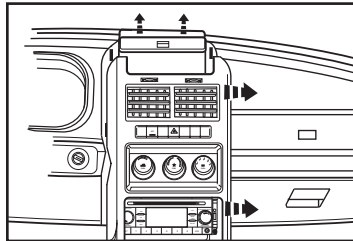

(Figure A)

Dodge Caliber 2009-2012/Challenger 2008-up, Jeep Compass/Patriot 2009-up

1. Unsnap and move shifter trim to the side. (Figure A)
2. Unsnap center dash trim panel (do not remove until climate controls are removed). (Figure A)
3. Remove (4) Phillips screws holding climate control panel to backside of the center dash panel.
4. Remove (4) 7mm screws securing radio. Unplug and remove radio.
5. The metal bracket in the sub-dash will need to be removed for the aftermarket Double DIN radio's depth.

Continue to kit assembly



(Figure A)

Dodge Ram 1500 2009-2011, Dodge Ram 2500/3500 2010-2011, Dodge Ram Chassis Cab 2011, Ram 1500 2012, Ram 2500/3500 2012-up, Ram Chassis Cab 2012-up

1. Remove (1) T25 Torx screw in the compartment next to the cup holders. (Figure A)
2. Remove (2) Phillips screws in the pocket below the climate control in the front of the center console. (Figure B)
3. Remove (2) 9/32" screws in the cup holders. (Figure C)

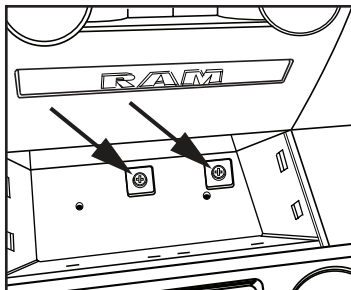

(Figure B)

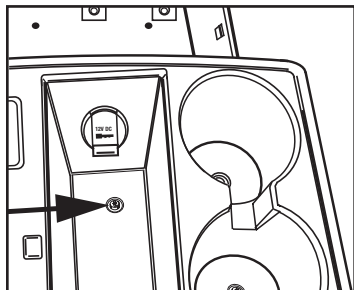

(Figure A)

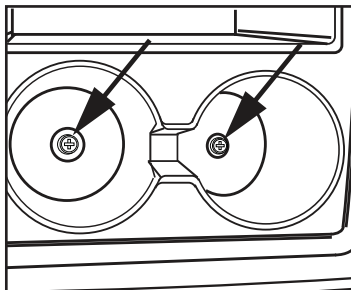

(Figure C)

4. Push down on the collar below the shifter then pull the shifter straight up to remove. (Figure D)
5. Unclip and remove the top of the center console including the cup holders. (Figure E)
6. Unclip and remove the trim panel from the accessory socket on the radio trim panel, then remove (1) T25 Torx screw. (Figure F)

Continued on next page

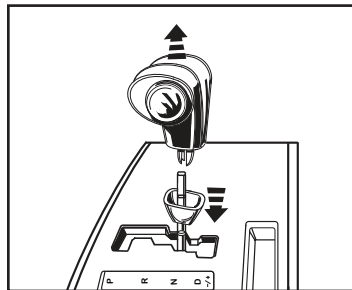

(Figure D)

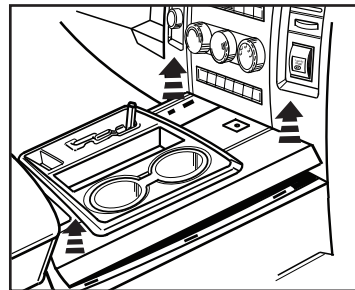

(Figure E)

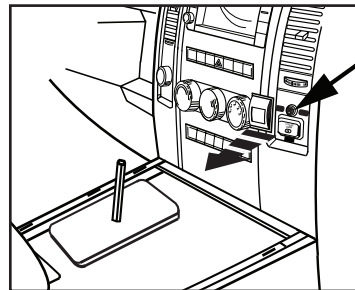

(Figure F)

Dodge Ram 1500 2009-2011, Dodge Ram 2500/3500 2010-2011, Dodge Ram Chassis Cab 2011, Ram 1500 2012, Ram 2500/3500 2012-up, Ram Chassis Cab 2012-up

7. Remove (2) T25 Torx screws from the top of the radio trim panel. (Figure G)
8. Unclip and remove the entire radio trim panel including the climate controls. (Figure H)
9. Remove (4) 9/32" screws securing the radio. (Figure I)

Continue to kit assembly

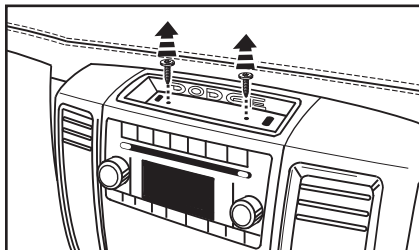

(Figure G)

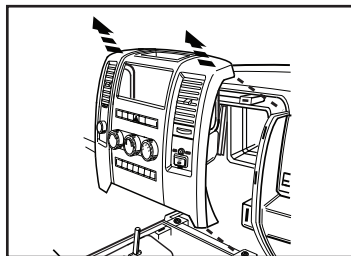

(Figure H)

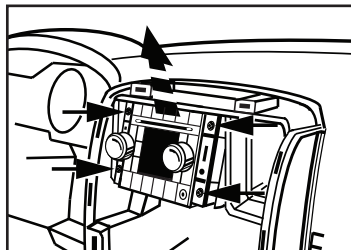

(Figure I)

Ram C/V Tradesman 2012-up

1. Remove the radio trim bezel. (Figure A)
2. Remove (4) screws securing the radio to the dash. (Figure B)

Continue to kit assembly

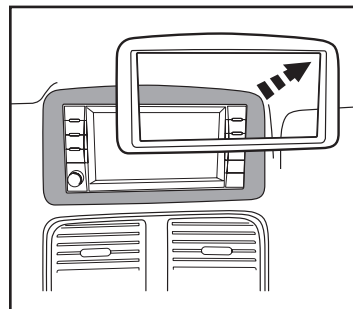

(Figure A)

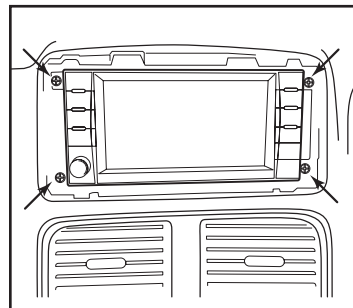

(Figure B)

Jeep Commander/Grand Cherokee 2008-2010

1. Unsnap and remove the small trim around the console shifter. (Figure A)
2. Unsnap and remove the larger trim around the console shifter. (Figure B)
3. Remove (1) Phillips screw from inside the small storage pocket in the lower dash, between the power outlets. (Figure C)
4. Unsnap and remove the dash panel from around the radio (including climate controls). (Figure D)
5. Remove (4) Phillips screws securing the radio. Unplug and remove radio.
Continue to kit assembly

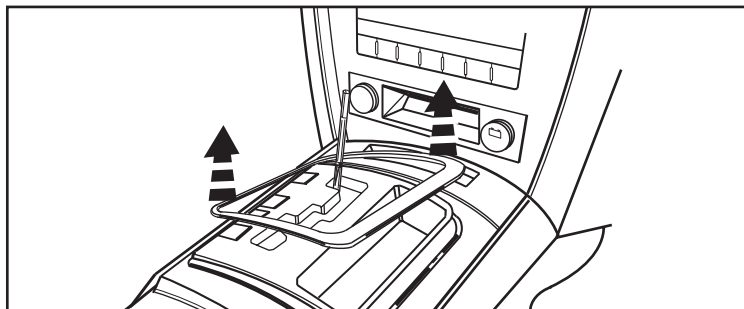

(Figure A)

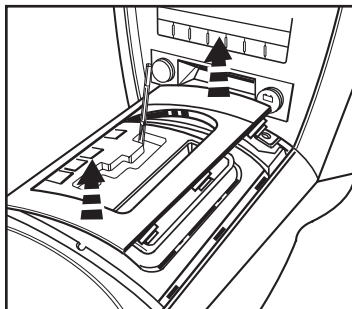

(Figure B)

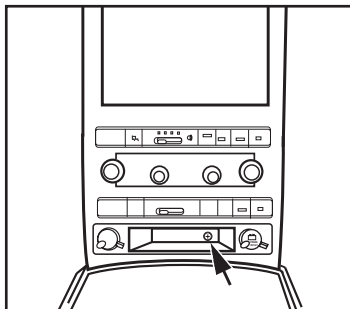

(Figure C)

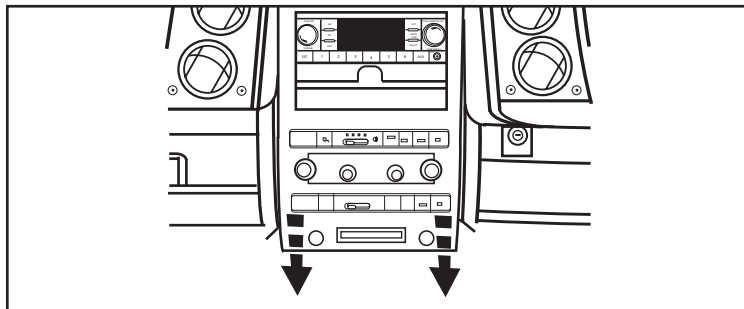

(Figure D)

Jeep Wrangler 2007-2010

(modifications to radio cavity required)

1. Unclip and remove the lower center trim below A/C controls. (Figure A)
2. Remove (2) Phillips screws exposed behind lower center panel. (Figure A)
3. Unclip and remove the upper center trim starting towards the rear of the panel. (Figure A)
4. Remove (2) Phillips screws exposed behind upper center panel. (Figure A)
5. Unclip and remove entire panel surrounding radio and climate controls, including A/C vents.
6. Remove (4) 7mm screws securing radio. Unplug and remove radio. (Figure B)

NOTE: The top of the metal bracket in the sub dash will need to be cut to allow for the clearance of the Double DIN radio's chassis.

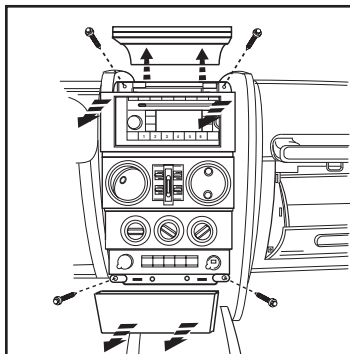

(Figure A)

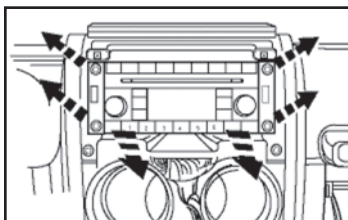

(Figure B)

Jeep Wrangler 2011-up

(modifications to radio cavity required)

1. Unclip and remove the power window switches then remove (1) 9/32" screw from underneath. (Figure A)
2. Unclip and remove the panel below the steering column.
3. Remove (2) 9/32" screws from the bottom edge of the radio/instrument cluster trim panel on either side of the steering column. (Figure B, C)

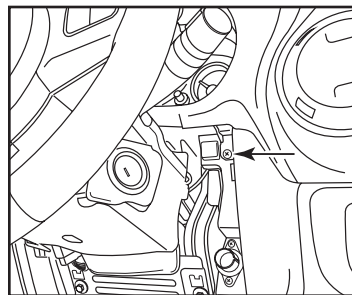

(Figure B)

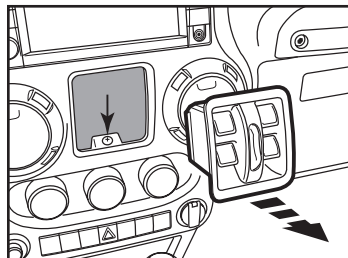

(Figure A)

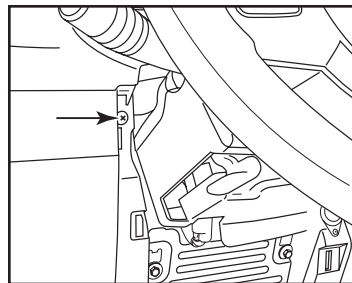

(Figure C)

Jeep Wrangler 2011-up

(modifications to radio cavity required)

4. Remove pad in pocket on top center of dash then remove (1) 9/32" screw underneath. Remove dash panel from around radio and instrument cluster. (Figure D)
5. Remove (4) 9/32" screws securing the radio. Unplug and remove radio.
6. Remove (2) 9/32" screws securing the metal bracket inside of the dash cavity and remove it for depth. (Figure E)
7. A small cut in the plastic at the top of the radio cavity will be required for most DDIN radios. (See inset)

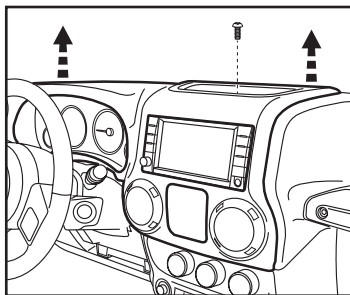

(Figure D)

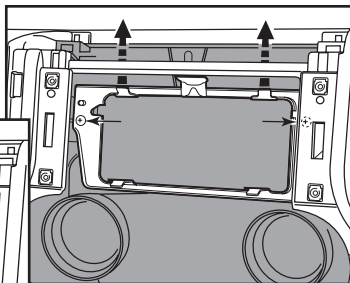

(Figure E)

Mitsubishi Raider 2008-2009

1. Unsnap and remove center dash panel. (Figure A)
2. Remove (4) 7mm screws securing the radio. Unplug and remove radio.

Continue to kit assembly

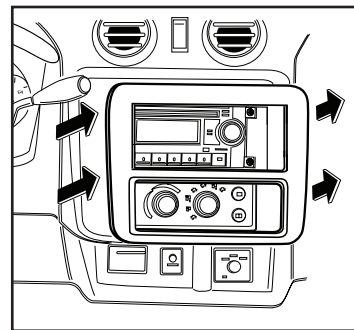

(Figure A)

Double DIN radio provision

1. Locate the factory wiring harness in the dash. Metra recommends using the proper mating adapter from Metra or AXCESS. Re-connect the negative battery terminal and test the unit for proper operation.
2. Attach the Double DIN brackets/trim plates to the Double DIN radio using the screws supplied with the radio. (Figure A)
3. Reassemble dash in reverse order of disassembly.

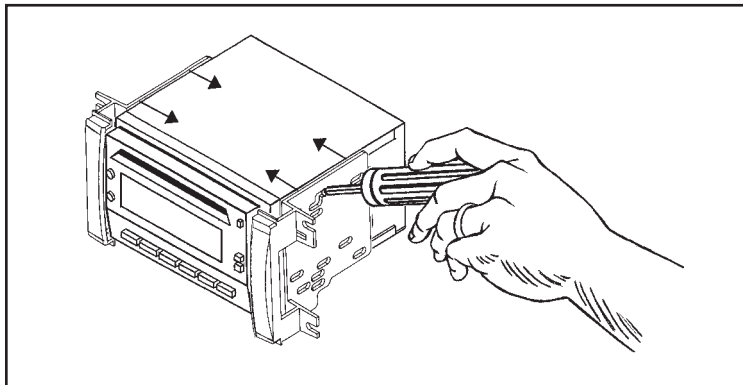

(Figure A)

Stacked ISO head unit provision

1. Locate the factory wiring harness in the dash. Metra recommends using the proper mating adapter from Metra or AXCESS. Re-connect the negative battery terminal and test the unit for proper operation.
2. Attach the Double DIN brackets/trim plates to the stacked ISO units using the screws supplied with the units. (Figure A)
3. Reassemble dash in reverse order of disassembly.

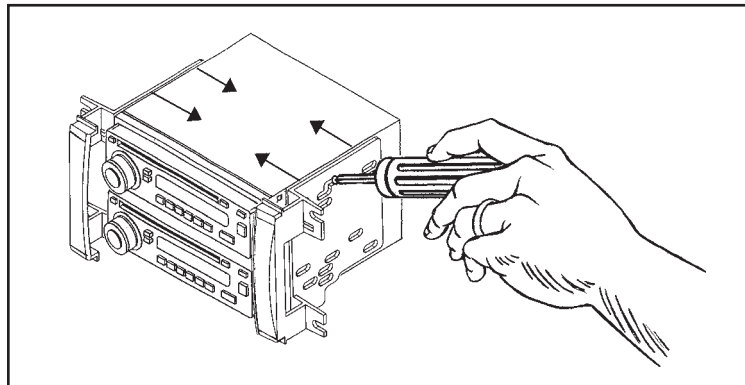

(Figure A)

DIN radio provision with pocket

1. Slide the DIN cage into the radio housing and secure by bending the metal locking tabs outward. (Figure A)
2. Slide the aftermarket radio into the DIN cage until it snaps into place. (Figure B)
3. Locate the factory wiring harness in the dash. Metra recommends using the proper mating adapter from Metra or AXXESS. Re-connect the negative battery terminal and test the unit for proper operation.
4. Reassemble dash in reverse order of disassembly.

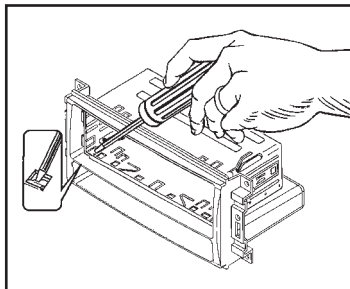

(Figure A)

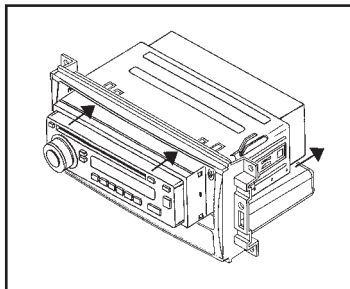

(Figure B)

ISO radio provision with pocket

1. Mount the ISO brackets to the radio using the screws supplied with the radio. (Figure A)
2. Slide the radio into the radio opening until it snaps into place. (Figure B)
2. Snap the ISO trim plate onto the front of the radio housing. (Figure B)
4. Locate the factory wiring harness in the dash. Metra recommends using the proper mating adapter from Metra or AXXESS. Re-connect the negative battery terminal and test the unit for proper operation.
5. Reassemble dash in reverse order of disassembly.

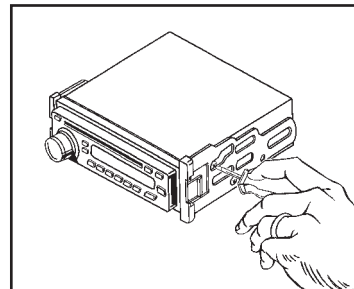

(Figure A)

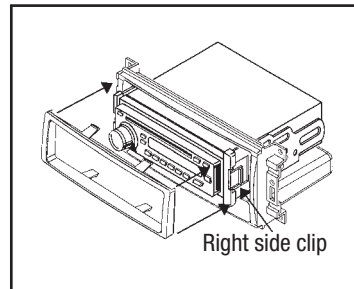

(Figure B)



INSTALLATION INSTRUCTIONS FOR PARTS 95-6511 or 99-6511



REV 11/20/2013 INST-6511



KNOWLEDGE IS POWER

Enhance your installation and fabrication skills by enrolling in the most recognized and respected mobile electronics school in our industry. Log onto www.installerinstitute.com or call 800-354-6782 for more information and take steps toward a better tomorrow.



Metra recommends MECP certified technicians



INSTRUCCIONES DE INSTALACIÓN PARA LA PIEZA 95-6511 o 99-6511

APLICACIONES

Lista de aplicaciones dentro

Chrysler multi-kit 2007 y mas 95-6511 o 99-6511

CARACTERÍSTICAS DEL KIT

95-6511:

- Provisión de radio doble DIN
- Provisión de radio ISO vertical

99-6511:

- Provisión de radio DIN con bolsillo
- Provisión de radio ISO con bolsillo



COMPONENTES DEL KIT

95-6511: • A1) Soportes doble DIN/placa de moldura

99-6511: • A2) Alojamiento del radio con bolsillo • B2) Soportes ISO • C2) Placa de moldura ISO

A1

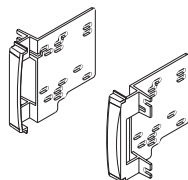

A2

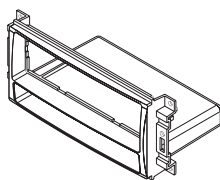

B2

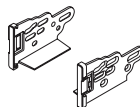

C2

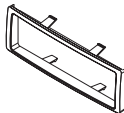

CABLEADO Y CONEXIONES DE ANTENA

Arnés de cableado: (se venden por separado)

- XSVI-6522-NAV - Arnés Chrysler CAN RAP 2007 y mas
- CHTO-03 - Arnés Chrysler CAN con amplificador 2007 y mas

Adaptador de antena:

- 40-EU10 - Adaptador de antena europeo 2002 y mas

HERRAMIENTAS REQUERIDAS

- Herramienta de remoción de panel
- Destornillador Phillips • Destornillador de hoja plana pequeño • Conjunto de receptáculo
- Herramienta de corte (*modificaciones de radio cavidad necesario para la mayoría de aplicaciones doble DIN 95-6511*)

PRECAUCIÓN: Metra recomienda desconectar el terminal negativo de la batería antes de comenzar cualquier instalación. Todos los accesorios, interruptores y, especialmente, las luces indicadoras de airbag deben estar enchufados antes de volver a conectar la batería a comenzar el ciclo de ignición.

NOTA: Remítase a las instrucciones incluidas con el radio de postventa.

Aplicaciones

Chrysler	Commander 2008-2010
200 2011-2013	Grand Cherokee 2008-2010
300/300C 2008-2010	Patriot 2009 y mas
Aspen 2008-2009	Liberty 2008-2012
Sebring 2007-2010	Wrangler** 2007 y mas
Town and Country 2008 y mas	
Dodge	Mitsubishi
Avenger 2007 y mas	Raider 2008-2009
Caliber 2009-2012	
Challenger 2008 y mas	Ram
Charger 2008-2010	1500 2012
Dakota 2008-2011	2500/3500 2012 y mas
Durango 2008-2009	Chassis Cab 2012 y mas
Grand Caravan 2008 y mas	C/V Tradesman 2012 y mas
Journey** 2009-2010	
Magnum 2008-2009	VW
Nitro 2007-2011	Routan 2009-2012
Ram 1500 2009-2011	
Ram 2500/3500 2010-2011	
Jeep	
Compass 2009 y mas	

** (modificaciones a la cavidad de radio requerido)

Indice

Desmontaje del tablero	– Dodge Ram Chassis Cab 2011 9-10
– Chrysler Aspen 2008-2009/ Dodge Durango 2008-2009 3	– Jeep Compass 2009 y mas 8
– Chrysler Sebring 2007-2010 3	– Jeep Patriot 2009 y mas 8
– Chrysler Town and Country 2008-2010 4	– Jeep Commander/ Grand Cherokee 2008-2010 11
– Chrysler Town and Country 2011 y mas 5	– Jeep Wrangler 2007-2010** 12
– Chrysler 200 2011-2013 5	– Jeep Wrangler 2011 y mas** 12-13
– Chrysler 300/300c 2008-2010 6	– Mitsubishi Raider 2008-2009 12
– Dodge Avenger 2008 y mas 6	– Ram 1500 2012 9-10
– Dodge Caliber 2009-2012 8	– Ram 2500/3500 2012 y mas 9-10
– Dodge Challenger 2008 y mas 8	– Ram Chassis Cab 2012 y mas 9-10
– Dodge Charger 2008-2010 6	– Ram C/V Tradesman 2012 y mas 10
– Dodge Dakota 2008-2011 7	– VW Routan 2009 y mas 5
– Dodge Grand Caravan 2008-2010 4	
– Dodge Grand Caravan 2011 y mas 5	Ensamble del kit
– Dodge Journey 2009-2010** 8	– Provisión de radio doble DIN 13
– Dodge Magnum 2008-2009 6	– Provisión de radio ISO vertical 13
– Dodge Nitro 2007-2011/ Jeep Liberty 2008-2012 7	– Provisión de radio DIN con bolsillo 14
– Dodge Ram 1500 2009-2011 9-10	– Provisión de radio ISO con bolsillo 14
– Dodge Ram 2500/3500 2010-2011 9-10	

** (modificaciones a la cavidad de radio requerido)

Chrysler Aspen 2008-2009 Dodge Durango 2008-2009

1. Suelte a presión y retire el ensamble de almacenamiento/portavasos. (Figura A)
2. Retire los (2) tornillos del borde inferior del panel de la moldura del tablero central. Suelte y retire el panel. (Figura B)
3. Retire los (4) tornillos que sostienen el radio. Desconecte y retire el radio. (Figura C)

Continuará al ensamble del kit

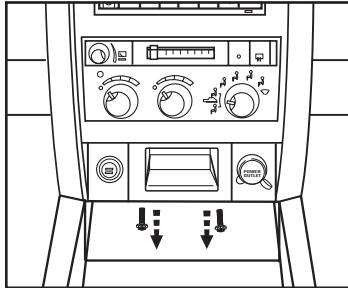

(Figura B)

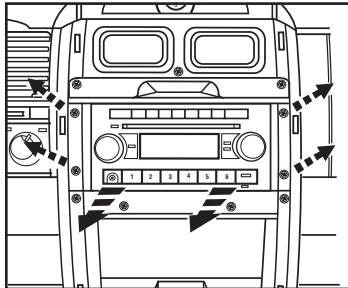

(Figura C)

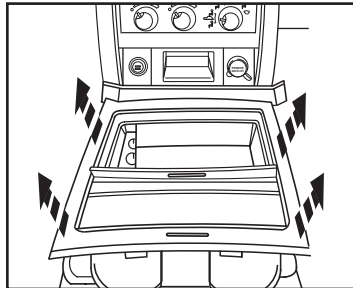

(Figura A)

Chrysler Sebring 2007-2010

1. Desenganche todo el panel que rodea el radio, incluyendo las rejillas del aire acondicionado y el reloj. Desconecte y retire el panel. (Figura A)
2. Retire los (4) tornillos de 7mm que sostienen el radio. Desconecte y retire el radio. (Figura B)

Continuará al ensamble del kit

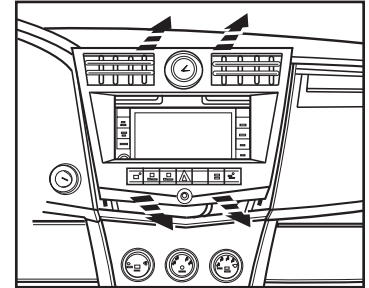

(Figura A)

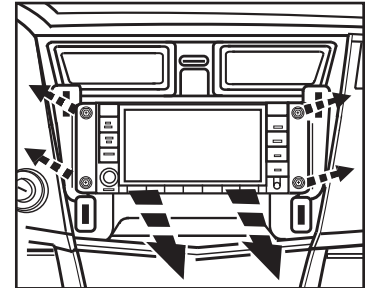

(Figura B)

Chrysler Town and Country 2008-2010 Dodge Grand Caravan 2008-2010

1. Retire las (2) tapas de los tornillos orientadas hacia arriba sobre el radio, luego retire los (2) tornillos Phillips expuestos. (Figura A)
2. Levante el panel de arriba del radio y luego retire los (2) tornillos Phillips expuestos en el borde frontal del panel de la moldura del radio. (Figura B)
3. Retire las (3) chinchetas de plástico por lado del panel de la moldura inferior y luego del panel lateral hacia la parte trasera de la van para obtener acceso a los (2) tornillos de la parte inferior del panel de la moldura del radio. (Figura C)

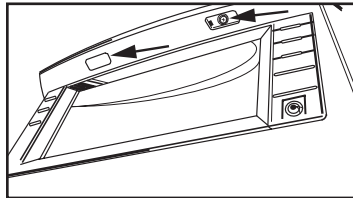

(Figura A)

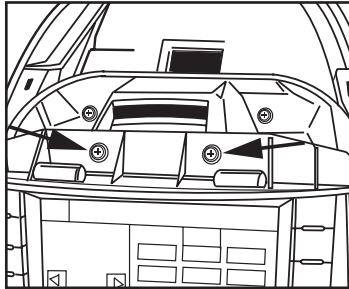

(Figura B)

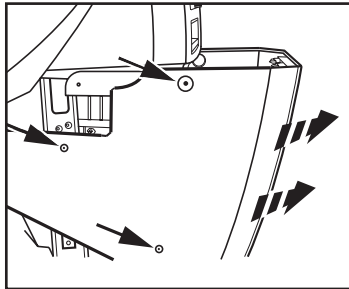

(Figura C)

4. Retire los (2) tornillos Phillips expuestos del panel de la moldura del radio del borde inferior. (Figura D)
5. Desenganche y retire todo el panel que rodea el radio, incluyendo los controles del clima, las rejillas y el reloj. (Figura E)
6. Retire los (4) tornillos Phillips que sostienen el radio. (Figura F)

Continuará al ensamble del kit

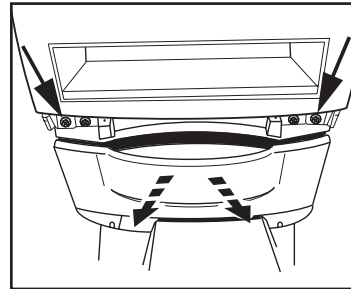

(Figura D)

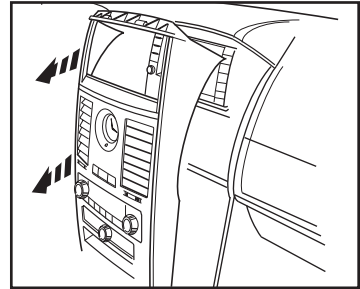

(Figura E)

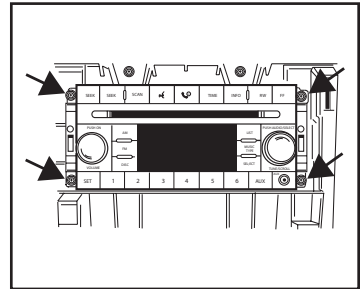

(Figura F)

Chrysler Town and Country 2011 y mas Dodge Grand Caravan 2011 y mas Volkswagen Routan 2009 y mas

1. Desenganche y retire el panel de moldura para radio. (Figura A)
2. Retire los (4) tornillos Torx que sostienen el radio. (Figura B)

Continuará al ensamble del kit

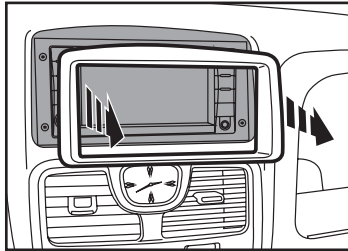

(Figura A)

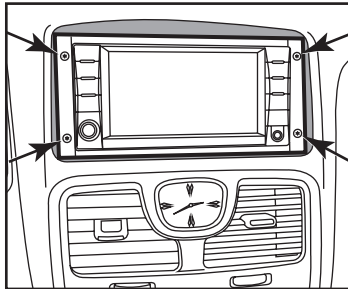

(Figura B)

Chrysler 200 2011-2013

1. Desenganche y retire el panel de moldura para radio. (Figura A)
2. Retire los (4) tornillos Torx que sostienen el radio. (Figura B)

Continuará al ensamble del kit

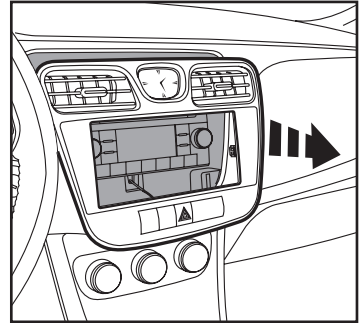

(Figura A)

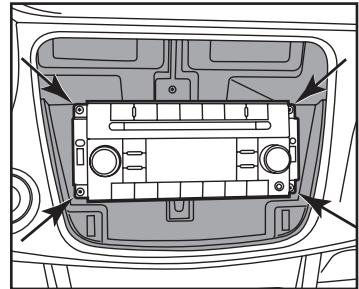

(Figura B)

**Chrysler 300/300C 2008-2010, Dodge
Magnum 2008-2009/Charger 2008-2010**

1. Suelte a presión y retire el panel de la moldura del tablero central. (Figura A)
2. Retire los (4) tornillos que sostienen el radio. Desconecte y retire el radio. (Figura B)

Continuará al ensamble del kit

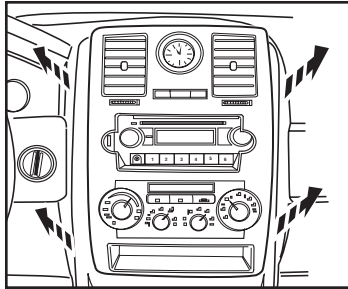

(Figura A)

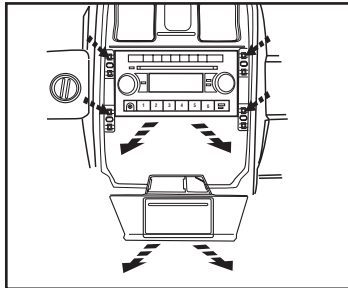

(Figura B)

Dodge Avenger 2008 y mas

1. Desenganche y retire el panel de la moldura de la consola central. (Figura A)
2. Desenganche el panel de la moldura del tablero central. (Figura B)
3. Retire los (4) tornillos que sostienen el radio. Desconecte y retire el radio. (Figura C)
4. Retire los (3) tornillos que sujetan el soporte de apoyo trasero del radio y retire el soporte. (Figura D)

Continuará al ensamble del kit

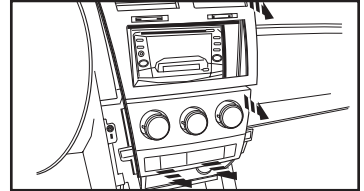

(Figura B)

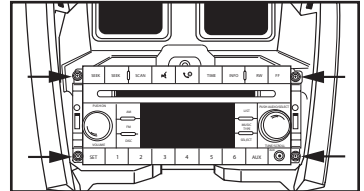

(Figura C)

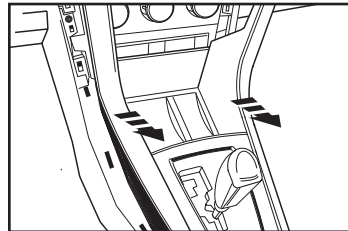

(Figura A)

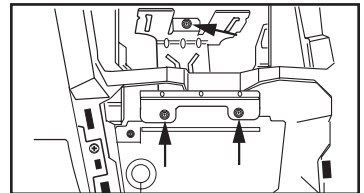

(Figura D)

Dodge Dakota 2008-2011

1. Desenganche y retire el panel de moldura que rodea el radio. (Figura A)
2. Retire los (4) tornillos Phillips que sostienen el radio. (Figura B)

Continuará al ensamble del kit

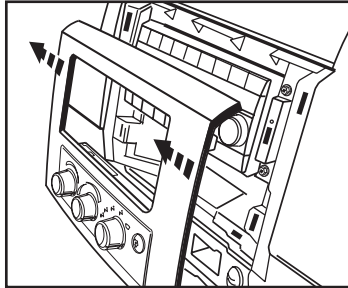

(Figura A)

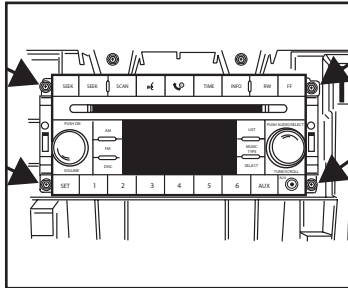

(Figura B)

**Dodge Nitro 2007-2011
Jeep Liberty 2008-2012**

1. Desenganche todo el panel que rodea el radio y los controles del clima, incluyendo las rejillas del aire acondicionado. Desconecte y retire el panel. (Figura A)
2. Retire los (4) tornillos de 7mm que sostienen el radio. Desconecte y retire el radio. (Figura B)

Continuará al ensamble del kit

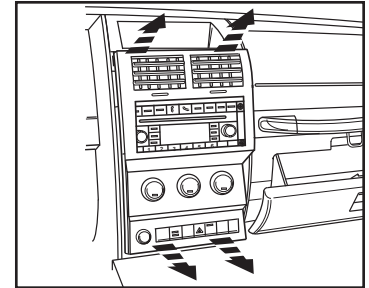

(Figura A)

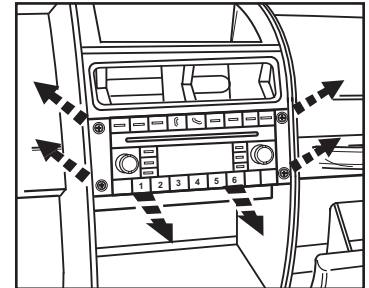

(Figura B)

Dodge Journey 2009-2010

(modificaciones a la cavidad de radio requerido)

1. Desenganche y retire todo el panel de la moldura del radio de fábrica, incluyendo los controles del aire acondicionado. (Figura A)

Sugerencia: Abra la puerta del compartimiento de la parte superior del panel de la moldura del radio.

2. Retire los (4) tornillos de 7mm que sujetan el radio al tablero y retire. (Figura B)

Nota: La parte superior del soporte metálico del sub tablero tendrá que cortarse para permitir que haya suficiente espacio para el chasis del radio doble DIN. (Figura C)

Continuará al ensamble del kit

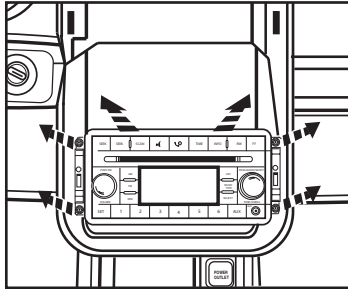

(Figura B)

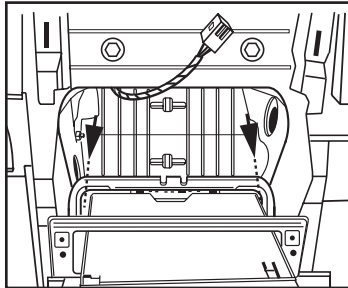

(Figura C)

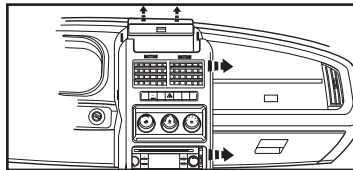

(Figura A)

Dodge Caliber 2009-2012/ Challenger 2008 y mas, Jeep Compass/ Patriot 2009 y mas

1. Suelte y mueva la moldura de la palanca de velocidades a un lado. (Figura A)
2. Suelte el panel de la moldura del tablero central (no lo retire hasta que se hayan retirado los controles de clima). (Figura A)
3. Retire los (4) tornillos Phillips que sostienen el panel de control de clima a la parte posterior del panel del tablero central.
4. Retire los (4) tornillos de 7mm que sostienen el radio. Desconecte y retire el radio.
5. El soporte metálico del sub tablero tendrá que retirarse por la profundidad del radio doble DIN de mercado secundario.

Continuará al ensamble del kit

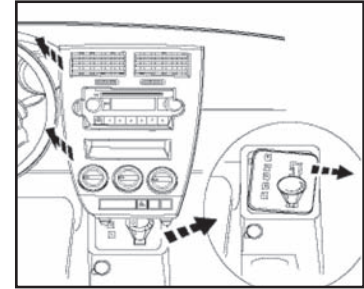

(Figura A)

Dodge Ram 1500 2009-2011, Dodge Ram 2500/3500 2010-2011, Dodge Ram Chassis Cab 2011, Ram 1500 2012, Ram 2500/3500 2012 y mas, Ram Chassis Cab 2012 y mas

1. Retire (1) tornillo Torx T25 del compartimiento junto a los portavasos. (Figura A)
2. Retire los (2) tornillos Phillips de la cavidad debajo del control de clima al frente de la consola central. (Figura B)
3. Retire los (2) tornillos de 9/32" de los portavasos. (Figura C)

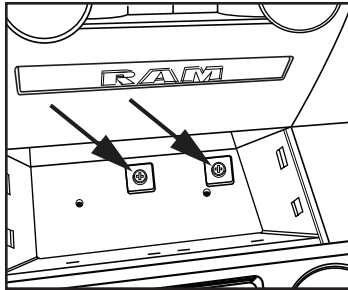

(Figura B)

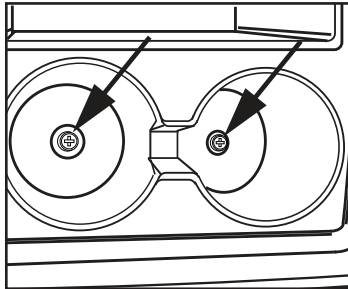

(Figura C)

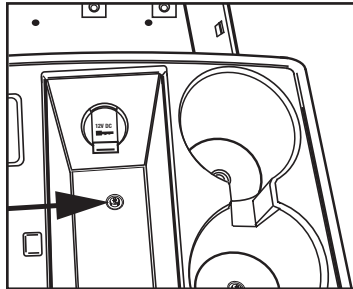

(Figura A)

4. Empuje hacia abajo el collar debajo de la palanca de velocidades, luego jale la palanca en línea recta hacia arriba para retirarla. (Figura D)
 5. Desenganche y retire la parte superior de la consola central, incluyendo los portavasos. (Figura E)
 6. Desenganche y retire el panel de la moldura del receptáculo de accesorios en el panel de la moldura del radio, luego retire (1) tornillo Torx T25. (Figura F)
- Continúa en la página*

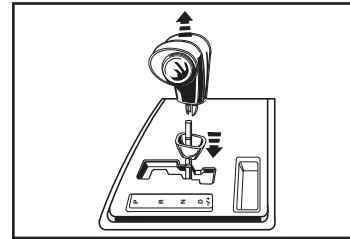

(Figura D)

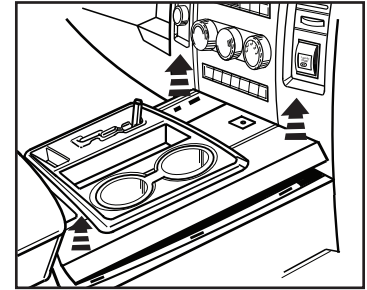

(Figura E)

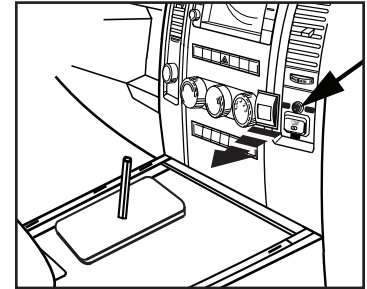

(Figura F)

Dodge Ram 1500 2009-2011, Dodge Ram 2500/3500 2010-2011, Dodge Ram Chassis Cab 2011, Ram 1500 2012, Ram 2500/3500 2012 y mas, Ram Chassis Cab 2012 y mas

7. Retire los (2) tornillos Torx T25 de la parte superior del panel de la moldura del tablero. (Figura G)
8. Desenganche y retire todo el panel de la moldura del radio, incluyendo los controles del clima. (Figura H)
9. Retire los (4) tornillos de 9/32" que sostienen el radio. (Figura I)
Continuará al ensamble del kit

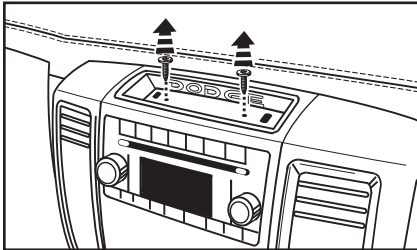

(Figura G)

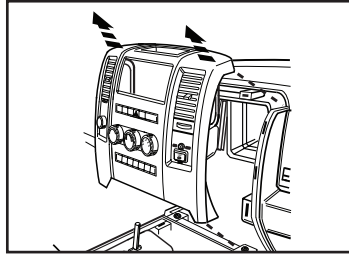

(Figura H)

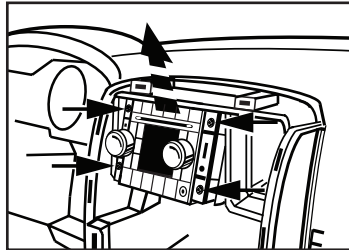

(Figura I)

Ram C/V Tradesman 2012 y mas

1. Retire el embellecedor para radio. (Figura A)
2. Retire (4) tornillos que sujetan el radio en el salpicadero. (Figura B)

Continuará al ensamble del kit

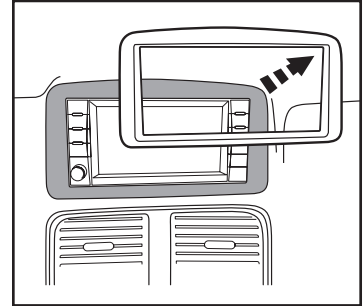

(Figura A)

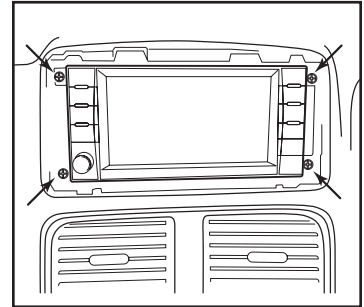

(Figura B)

Jeep Commander/Grand Cherokee 2008-2010

1. Suelte a presión y retire la moldura pequeña de alrededor de la palanca de velocidades de la consola. (Figura A)
2. Suelte a presión y retire la moldura más grande alrededor de la palanca de velocidades de la consola. (Figura B)
3. Retire (1) tornillo Phillips del interior de la pequeña cavidad de almacenamiento del tablero inferior, entre los tomacorrientes. (Figura C)
4. Suelte a presión y retire el panel del tablero de alrededor del radio (incluyendo los controles del clima). (Figura D)
5. Retire los (4) tornillos Phillips que sostienen el radio. Desconecte y retire el radio.

Continuará al ensamble del kit

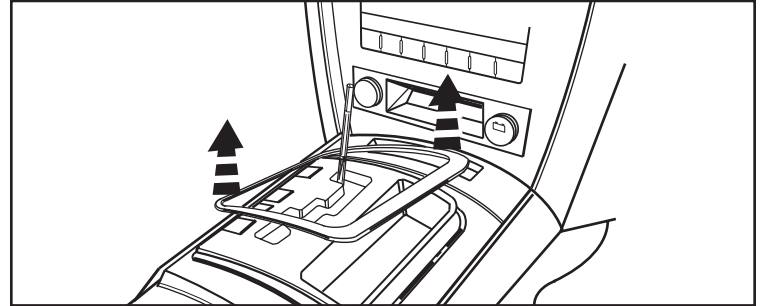

(Figura A)

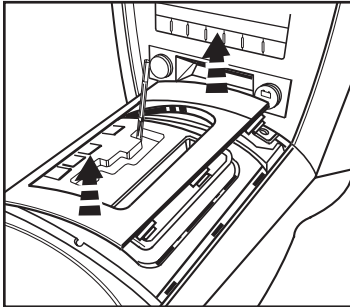

(Figura B)

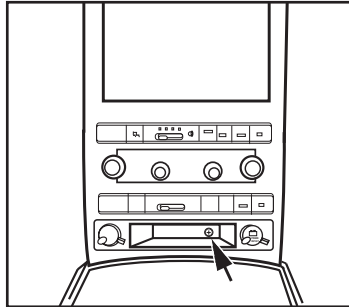

(Figura C)

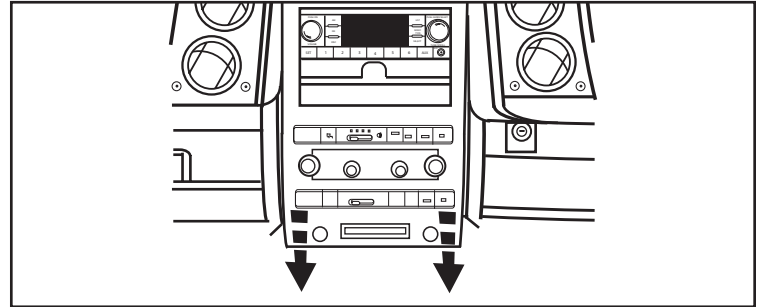

(Figura D)

Jeep Wrangler 2007-2010

(modificaciones a la cavidad de radio requerido)

1. Desenganche y retire la moldura central inferior debajo de los controles del aire acondicionado. (Figura A)
2. Retire los (2) tornillos Phillips expuestos detrás del panel central inferior. (Figura A)
3. Desenganche y retire la moldura central superior, empezando hacia la parte trasera del panel. (Figura A)

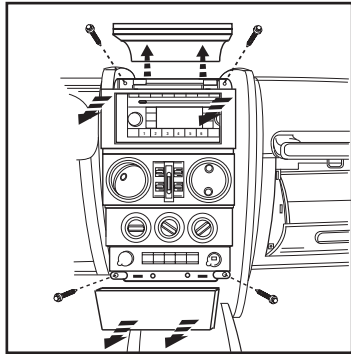

(Figura A)

4. Retire los (2) tornillos Phillips expuestos detrás del panel central superior. (Figura A)
5. Desenganche y retire todo el panel que rodea el radio y los controles del clima, incluyendo las rejillas del aire acondicionado.
6. Retire los (4) tornillos de 7mm que sostienen el radio. Desconecte y retire el radio. (Figura B)

Nota: La parte superior del soporte metálico del sub tablero tendrá que cortarse para permitir que haya suficiente espacio para el chasis del radio doble DIN.

Continuará al ensamble del kit

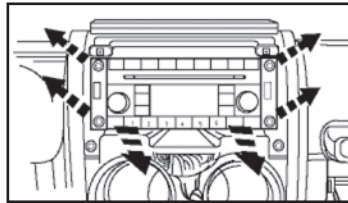

(Figura B)

Jeep Wrangler 2011 y mas

(modificaciones a la cavidad de radio requerido)

1. Soltar y quitar la ventana de interruptores de alimentación y luego retire (1) 9/32 "tornillo de debajo. (Figura A)
2. Suelte y quite el panel debajo de la columna de dirección.
3. Retire (2) 9/32 "tornillos desde el borde inferior del cuadro del panel de terminación del radio / instrumento a cada lado de la columna de dirección. (Figura B, C)

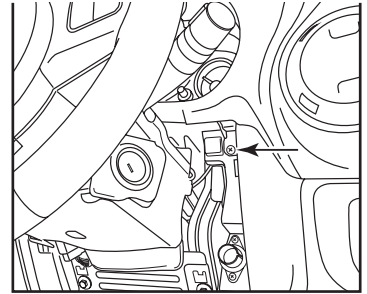

(Figura B)

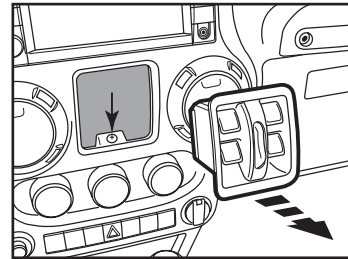

(Figura A)

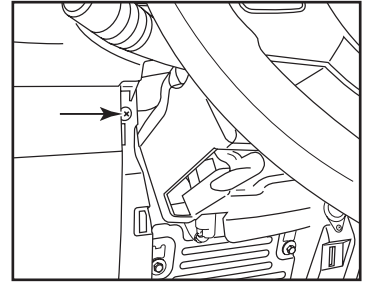

(Figura C)

Jeep Wrangler 2011 y mas

(modificaciones a la cavidad de radio requerido)

4. Quitar el disco en el bolsillo en la parte superior centro del tablero retire (1) 9/32 "por debajo de los tornillos. Retire tablero de instrumentos de todo radio y cuadro de instrumentos. (Figura D)
5. Retire (4) 9/32 "tornillos que sujetan el radio. Desenchufe y quite la radio.
6. Retire (2) 9/32 "tornillos que sujetan el soporte de metal en el interior de la cavidad del tablero y eliminar la profundidad. (Figura E)
7. Un pequeño corte en el plástico en la parte superior de la cavidad de radio se requiere para la mayoría de las radios DDIN. (Vea la imagen)

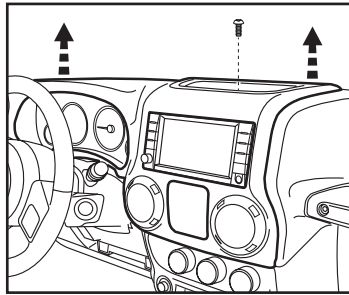

(Figura D)

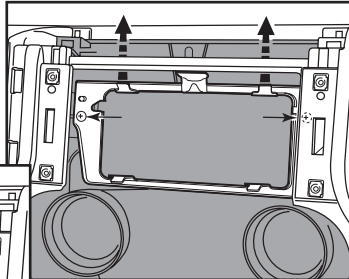

(Figura E)

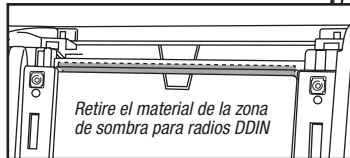

Mitsubishi Raider 2008-2009

1. Suelte y retire el panel del tablero central. (Figura A)
2. Retire los (4) tornillos de 7mm que sostienen el radio. Desconecte y retire el radio.

Continuará al ensamble del kit

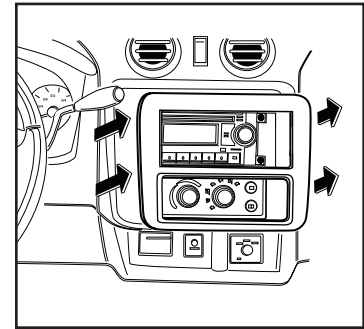

(Figura A)

Provisión de radio doble DIN

1. Ubique el arnés del cableado de fábrica en el tablero. Metra recomienda usar el adaptador de acoplamiento adecuado de Metra o AXCESS. Vuelva a conectar el terminal negativo de la batería y pruebe la unidad para verificar que funcione correctamente.
2. Una los soportes doble DIN/las placas de moldura al radio doble DIN con los tornillos suministrados con el radio. (Figura A)
3. Vuelva a montar el tablero en forma inversa al desmontaje.

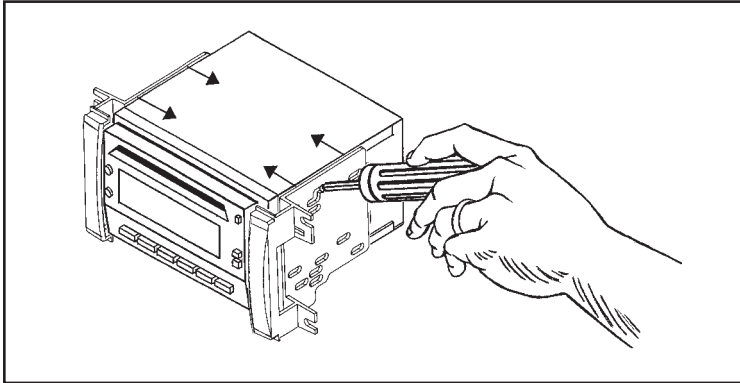

(Figura A)

Provisión de radio ISO vertical

1. Ubique el arnés del cableado de fábrica en el tablero. Metra recomienda usar el adaptador de acoplamiento adecuado de Metra o AXCESS. Vuelva a conectar el terminal negativo de la batería y pruebe la unidad para verificar que funcione correctamente.
2. Una los soportes doble DIN/las placas de moldura a las unidades ISO verticales con los tornillos suministrados con las unidades. (Figura A)
3. Vuelva a montar el tablero en forma inversa al desmontaje.

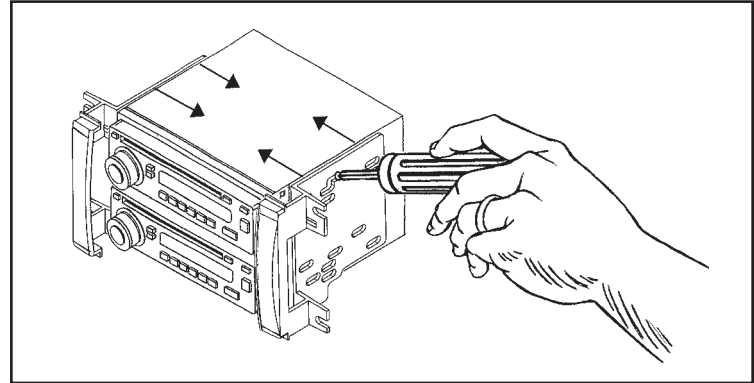

(Figura A)

Provisión de radio DIN con bolsillo

1. Deslice la caja DIN en el alojamiento del radio y sujétela doblando las lengüetas de cierre de metal hacia afuera. (Figura A)
2. Deslice el radio de posventa en la caja DIN hasta que calce a presión en su lugar. (Figura B)
3. Ubique el arnés del cableado de fábrica en el tablero. Metra recomienda usar el adaptador de acoplamiento adecuado de Metra o AXCESS. Vuelva a conectar el terminal negativo de la batería y pruebe la unidad para verificar que funcione correctamente.
4. Vuelva a montar el tablero en forma inversa al desmontaje.

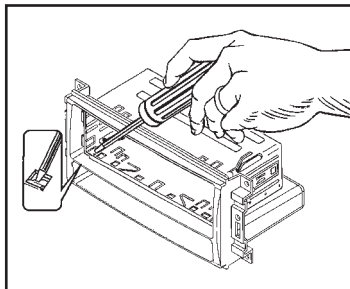

(Figura A)

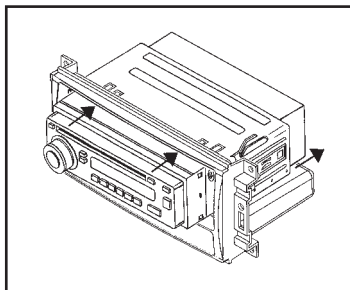

(Figura B)

Provisión de radio ISO con bolsillo

1. Monte los soportes ISO en el radio utilizando los tornillos suministrados con el radio. (Figura A)
2. Deslice el radio en la abertura del radio hasta que calce a presión en su lugar. (Figura B)
2. Coloque a presión la placa de terminación ISO en la parte delantera del alojamiento del radio. (Figura B)
4. Ubique el arnés del cableado de fábrica en el tablero. Metra recomienda usar el adaptador de acoplamiento adecuado de Metra o AXCESS. Vuelva a conectar el terminal negativo de la batería y pruebe la unidad para verificar que funcione correctamente.
5. Vuelva a montar el tablero en forma inversa al desmontaje.

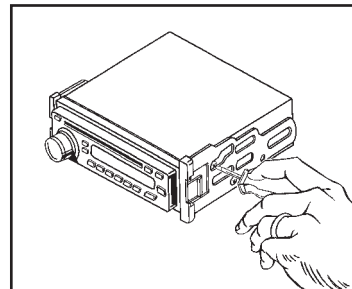

(Figura A)

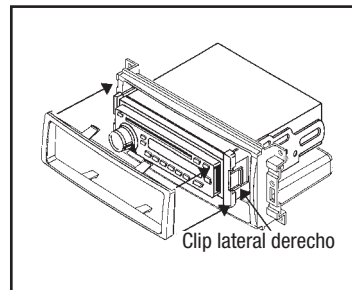

(Figura B)



INSTRUCCIONES DE INSTALACIÓN PARA LA PIEZA 95-6511 o 99-6511



REV 11/20/2013 INST-6511



EL CONOCIMIENTO ES PODER
Mejore sus habilidades de instalación y fabricación inscribiéndose en la escuela de dispositivos electrónicos móviles más reconocida y respetada de nuestra industria. Regístrese en www.installerinstitute.com o llame al 800-354-6782 para obtener más información y avance hacia un futuro mejor.



Metra recomienda técnicos con certificación del Programa de Certificación en Electrónica Móvil (Mobile Electronics Certification Program, MECP).