

## **r.LiNK Video-inserter**

### **RL2-PC-HSD**

**Compatible with Citroen and Peugeot vehicles  
with SMEG or SMEG+ infotainment system  
with 4pin HSD connector on the monitor**



example

**Video-inserter for rear-view camera  
and two additional video sources**

#### **Product features**

- **Video-inserter for factory-infotainment systems**
- **2 CVBS video-inputs for after-market devices (e.g. DVD-Player, DVB-T tuner)**
- **CVBS Rear-view camera video-input**
- **Automatic switching to rear-view camera input on engagement of reverse gear**
- **Activatable parking guide lines for rear-view camera (not available for all vehicles)**
- **Video-in-motion (ONLY for connected video-sources)**
- **Video inputs PAL/NTSC compatible**

## Contents

- 1. Prior to installation**
  - 1.1. ... Delivery contents
  - 1.2. Checking the compatibility of vehicle and accessories
  - 1.3. Boxes and connectors
    - 1.3.1. CAN-bus box
    - 1.3.2. Video-interface
  - 1.4. Dip-switch settings
    - 1.4.1. 8 dip - black
      - 1.4.1.1. ...Enabling the interface's video inputs (dip 2-3)
      - 1.4.1.2. Rear-view camera setting (dip 5)
      - 1.4.1.3. Monitor selection (dip 6-8)
    - 1.4.2. 4 dip - red
- 2. Installation**
  - 2.1. Place of installation
  - 2.2. Connection schema
  - 2.3. Connection - video-interface and CAN-box
  - 2.4. Connection - factory monitor
  - 2.5. Connection - head-unit
  - 2.6. Connecting – video sources
    - 2.6.1. Audio-insertion
    - 2.6.2. After-market rear-view camera
      - 2.6.2.1. Case 1: CAN-box detects reverse gear
      - 2.6.2.2. Case 2: CAN-box does not detect reverse gear
  - 2.7. Connection video-interface and keypad
  - 2.8. Picture settings and guide lines
- 3. Interface operation**
  - 3.1. By LIST-key
  - 3.2. By keypad
- 4. Specifications video-interface**
- 5. Frequently asked questions**
- 6. Technical support**

## Legal Information

By law, watching moving pictures while driving is prohibited, the driver must not be distracted. We do not accept any liability for material damage or personal injury resulting, directly or indirectly, from installation or operation of this product. This product should only be used while standing or to display fixed menus or rear-view-camera video when the vehicle is moving, for example the MP3 menu for DVD upgrades.

Changes/updates of the vehicle's software can cause malfunctions of the interface. If available, we offer free software-updates for our interfaces for one year after purchase. To receive a free update, the interface must be sent in at own cost. Labor cost for and other expenses involved with the software-updates will not be refunded.

## 1. Prior to installation

Read the manual prior to installation.

Technical knowledge is necessary for installation. The place of installation must be free of moisture and away from heat sources.

### 1.1. Delivery contents

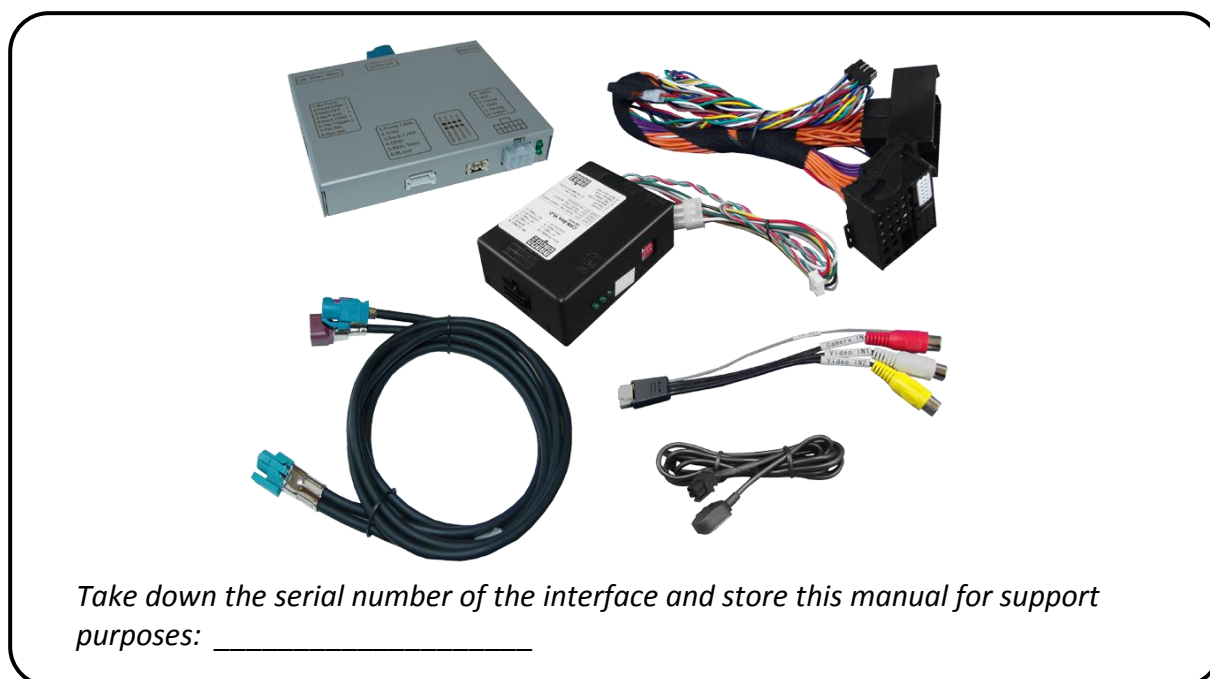

1.2. Checking the compatibility of vehicle and accessories

Voraussetzungen		
Brand	Model	Navigation
Citroen	Berlingo since model year 2015	SMEG/SMEG+/DS Connect Nav Touch Navigation
	C4 since model year 2015	
	C4 Cactus since model year 2014	
	C4 Picasso model year 2014-2016	
	DS3 since model year 2016	
DS4 since model year 2015-		
Peugeot	208 model year up to about 2016	SMEG or SMEG+ Touch
	2008 model year up to about 2016	
	308 model year 10/2013 bis 07.2017	
	508 since about model year 09/2014	

  

Limitations	
<i>Video only</i>	The interface inserts ONLY video signals into the infotainment. For inserting Audio signals either the possibly existing factory audio-AUX-input or a FM-modulator can be used. If 2 audio sources shall be connected to the infotainment, an additional electronic is necessary to switch them.
<i>Factory rear-view camera</i>	Automatic switch-back from inserted video to factory rear-view camera only while reverse gear is engaged. To extend the switch-back additional electronics is required.
<i>Guidelines</i>	If the video interface does not receive the required information from the vehicle CAN-bus, the guide-lines will not be supported.

1.3. Boxes and connectors

1.3.1. CAN-bus box

The CAN-bus box reads digital signals from the vehicle’s CAN-bus and converts them for the video-interface.

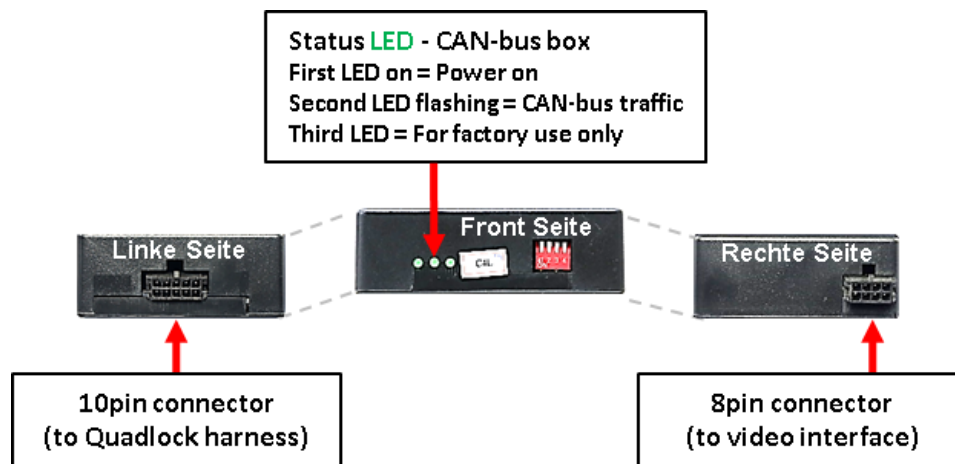

### 1.3.2. Video-interface

The video-interface converts the video signals of connected after-market sources in a factory monitor compatible picture signal which is inserted in the factory monitor, by using separate trigger options. Further it reads the vehicle's digital signals out of the vehicle's CAN-bus and converts them for the video interface.

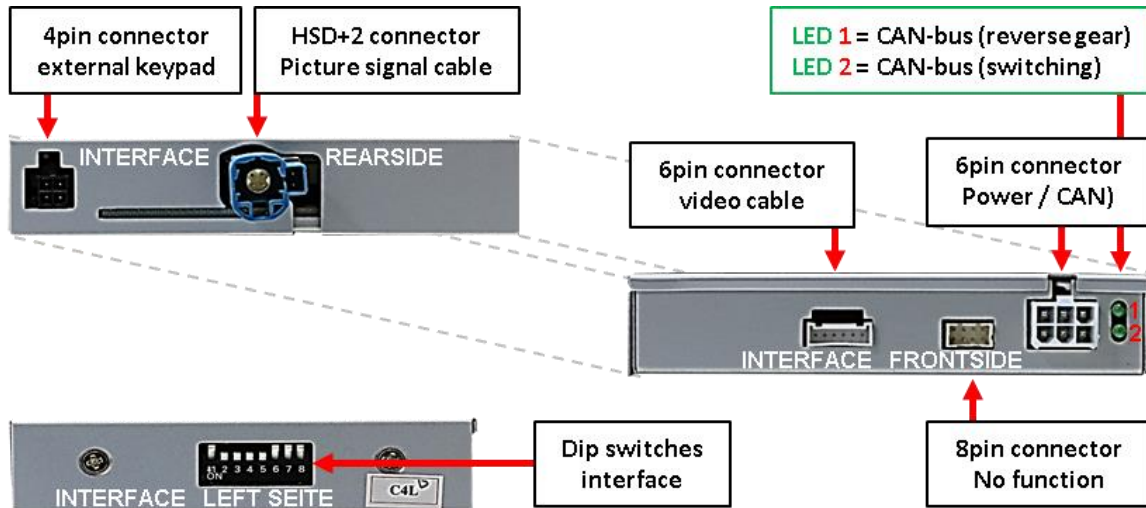

### 1.4. Dip-switch settings

#### 1.4.1. 8 dip - black

Some settings must be selected by the dip-switches on the video interface. Dip position down is ON and position up is OFF.



Dip	Function	ON (down)	OFF (up)
1	No function	-	set OFF
2	CVBS AV1-input	enabled	disabled
3	CVBS AV2-input	enabled	disabled
4	No function	-	set OFF
5	Rear-view cam type	after-market	factory or none
6	Monitor specific adjustments	-	set OFF
7			set OFF
8			set OFF

See following chapters for detailed information.

### 1.4.1.1. Enabling the interface's video inputs (dip 1-3)

Only the enabled video inputs can be accessed when switching through the interface's video sources. It is recommended to enable only the required inputs for the disabled will be skipped when switching through the video interfaces inputs.

### 1.4.1.2. Rear-view camera setting (dip 5)

If set to OFF, the interface switches to factory LVDS picture while the reverse gear is engaged to display factory rear-view camera or factory optical park system picture.

If set to ON, the interface switches to its rear-view camera input CAM while the reverse gear is engaged.

### 1.4.1.3. Monitor selection (dip 7-8)

Dips are not used.

### 1.4.1.4. 4 dip – red

By using the dip-switches, the factory Head-unit or vehicle can be chosen which the interface will be connected to.

Dip position down is ON and position up is OFF.



Vehicle/Navigation	Dip 1	Dip 2	Dip 3	Dip 4
All vehicles	OFF	OFF	OFF	OFF

The experience values of the CAN bus dip settings are only exemplary. If the Can communication doesn't succeed, try other dip combinations

**After each Dip-switch-change a power-reset of the Video Interface has to be performed!**

## 2. Installation

**To install the interface, first switch off the ignition and disconnect the vehicle's battery. Please read the owner's manual of the car, regarding the battery's disconnection! If required, enable the car's Sleep-mode (hibernation mode)**

**In case the sleep-mode does not succeed, the disconnection of the battery can be done with a resistor lead.**

**If the necessary stabilized power supply for the interface is not taken directly from the battery, the chosen connection has to be checked for being constantly stabile.**

**The interface needs a permanent 12V source!**

### 2.1. Place of installation

The interface shell be installed on the backside of the factory monitor and head-unit.



2.2. Connection scheme

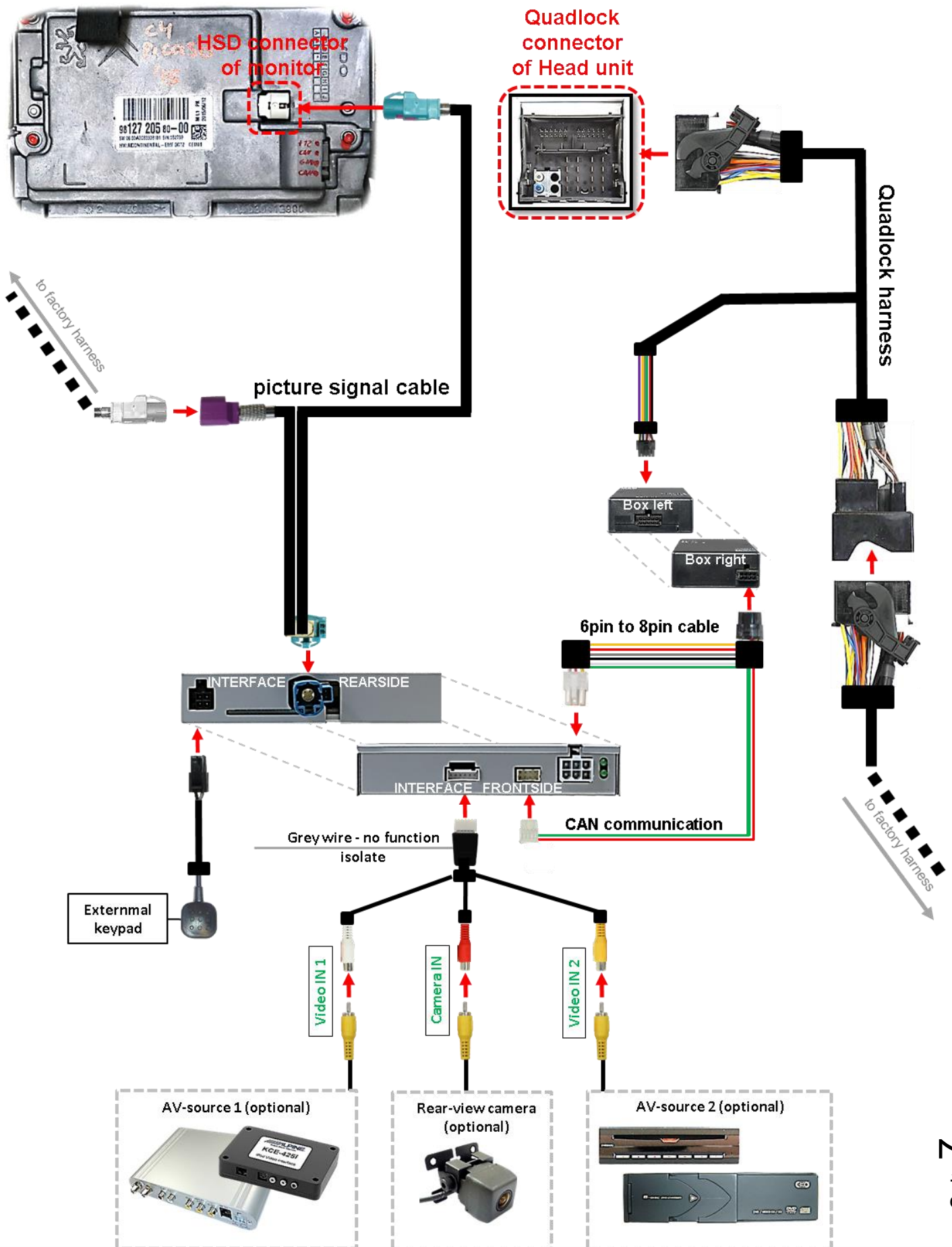

## 2.3. Connection - video-interface and CAN-box

The CAN-bus box reads digital signals from the CAN-bus and converts them for the video-interface. ACC +12V max. 0.5A (red of 6pin) and reverse gear +12V max. 0.5A (green of 6pin) constant signal. Video-source switching (white of 6pin) as +12V impulse.

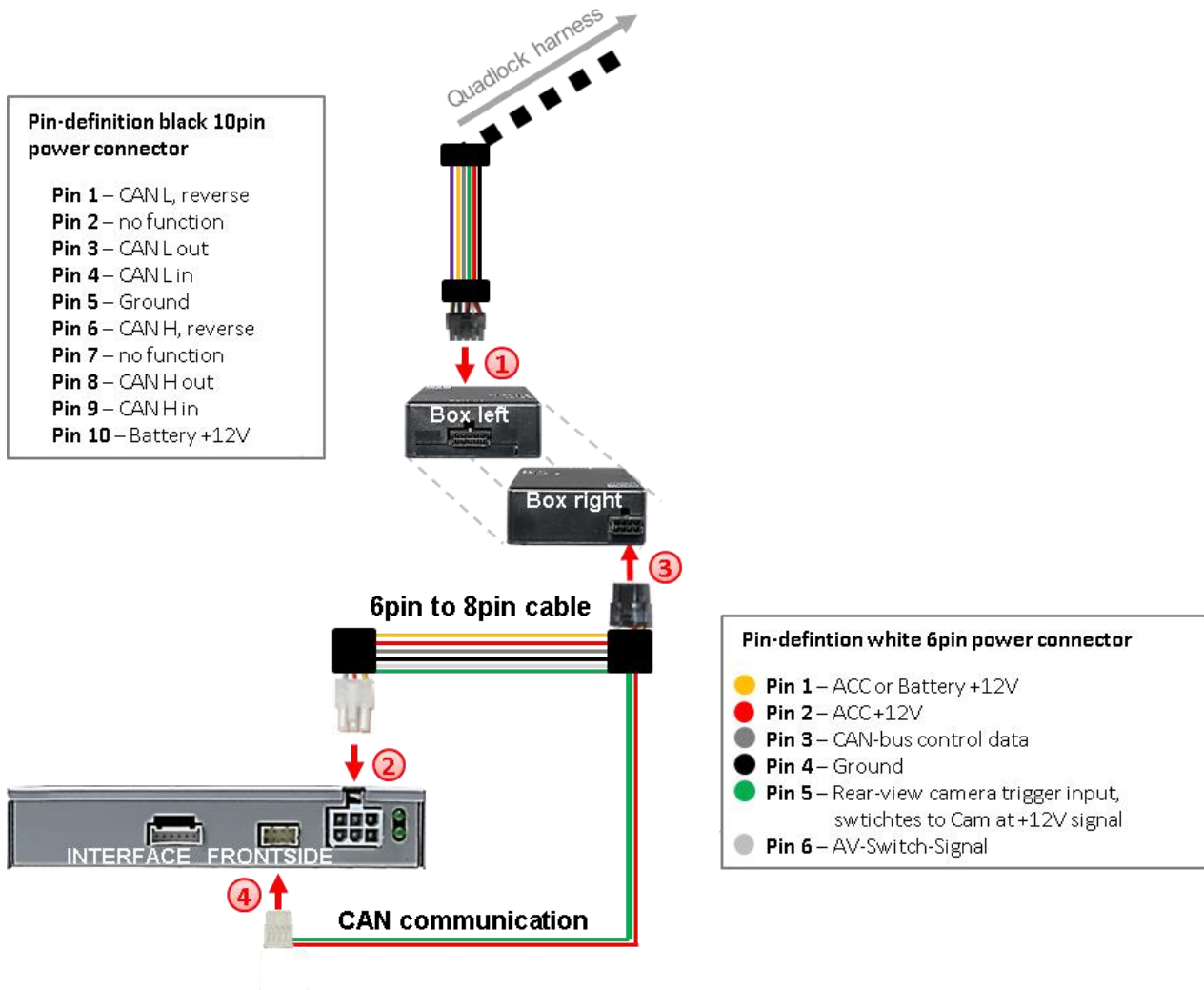

- ① Connect the black female 10pin connector of the Quadlock harness to the male 10pin connector of the CAN-box.
- ② Connect the white female 6pin connector of the 6pin to 8pin cable to the male 6pin connector of the video-interface.
- ③ Connect the black female 8pin connector of the 6pin to 8pin cable to the male 8pin connector of the CAN-box.
- ④ Connect the CAN communication cable's white female 8pin connector to the 8pin connector of the video interface.

**Note:** Check the LEDs on CAN-box after reconnecting the battery, two must be on. Not all vehicles are kompatible. If the CAN-box does not deliver ACC to pin2 of the video-interface or blocks the thevehicle's CAN, it is possible to install the video interface without the CAN-box. In this case see also note in chapter after-market rear-view camera if one is supposed to be connected.



## 2.4. Connection - factory monitor

Remove factory monitor.

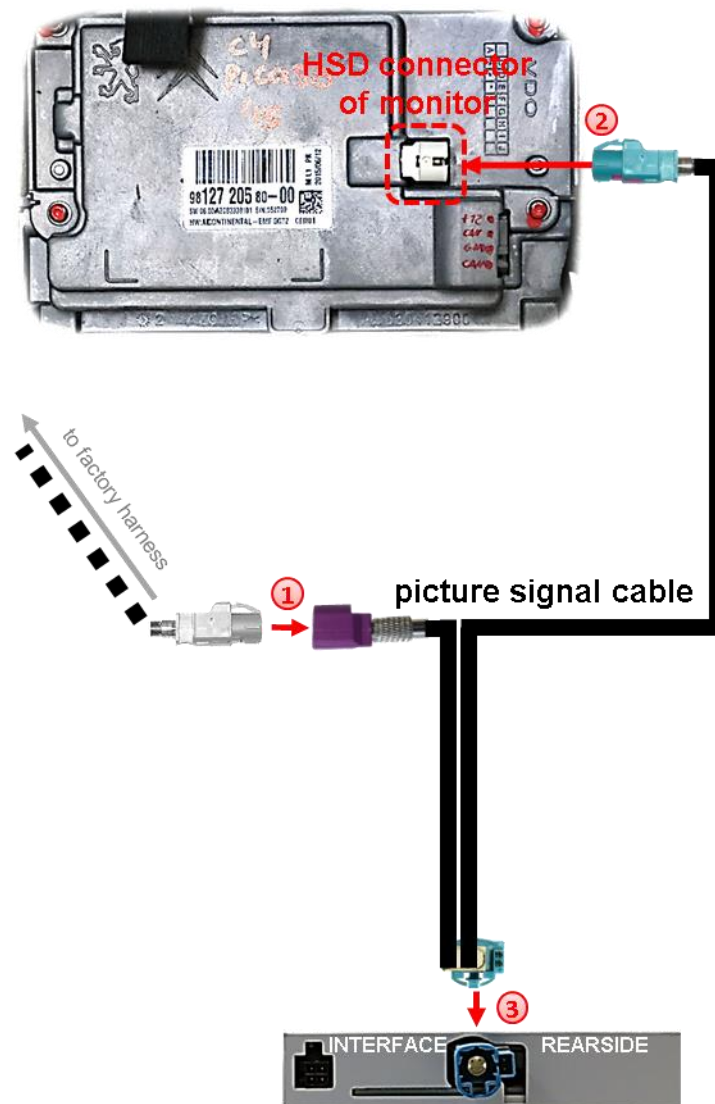

- 1 Remove the white female 4pin HSD connector from the rearside of the factory monitor and connect it to the aubergine colored male 4pin HSD connector of the picture signal cable.
- 2 Connect the waterblue colored female 4pin HSD connector of the picture signal cable to the white male 4pin HSD connector of the factory monitor.
- 3 Connect the waterblue colored female HSD+2 connector of the picture signal cable to the male HSD+2 connector of the video-interface.

## 2.5. Connection - head-unit

Remove head-unit.

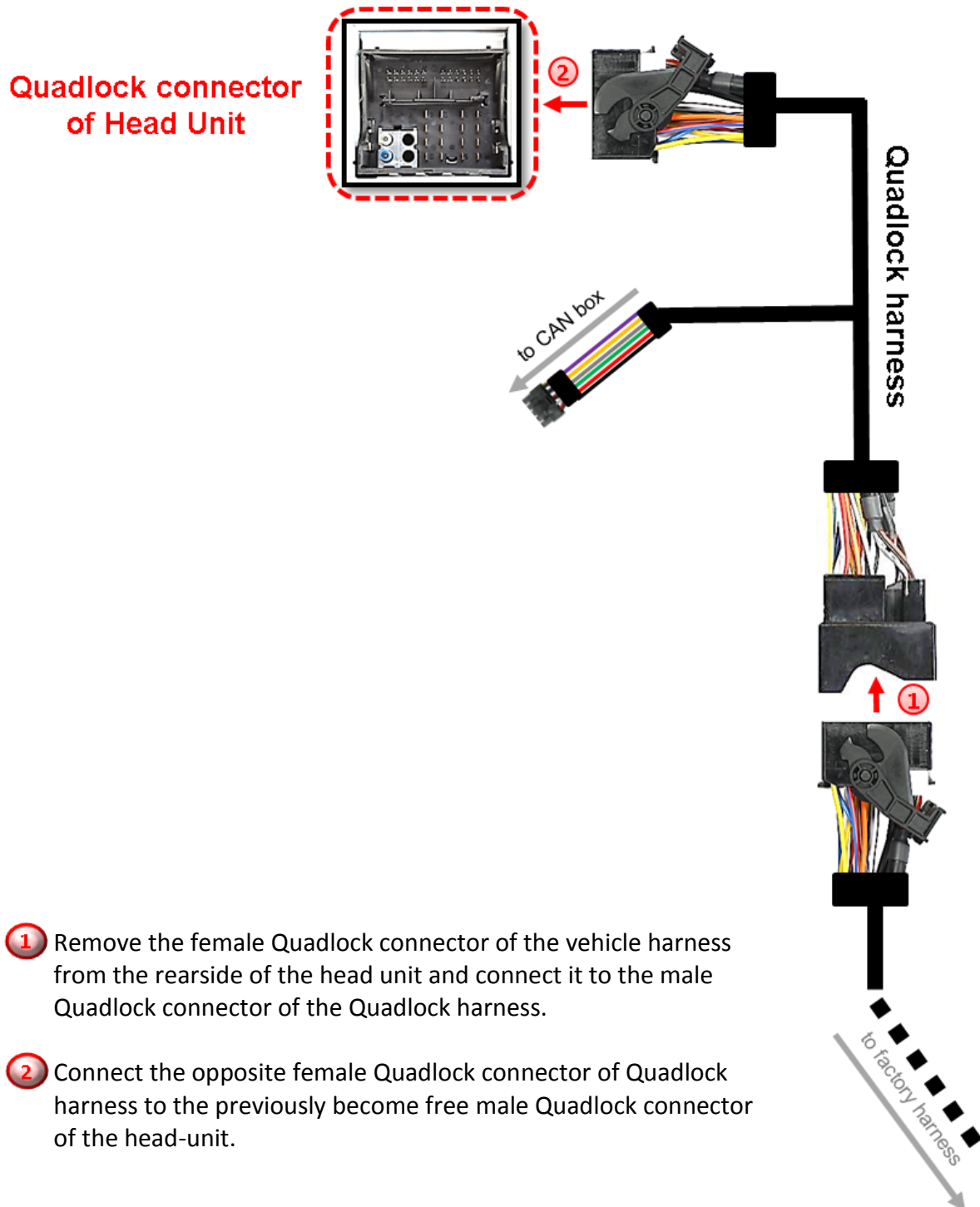

- ① Remove the female Quadlock connector of the vehicle harness from the rearside of the head unit and connect it to the male Quadlock connector of the Quadlock harness.
- ② Connect the opposite female Quadlock connector of Quadlock harness to the previously become free male Quadlock connector of the head-unit.

## 2.6. Connection – video sources

It is possible to connect 2 after-market Video-sources and 1 after-market rear-view camera to the video-interface.

Before final installation of the peripheral devices, we recommend a test-run of the interface. Due to changes in the production of the vehicle manufacturer is always the possibility of incompatibility.

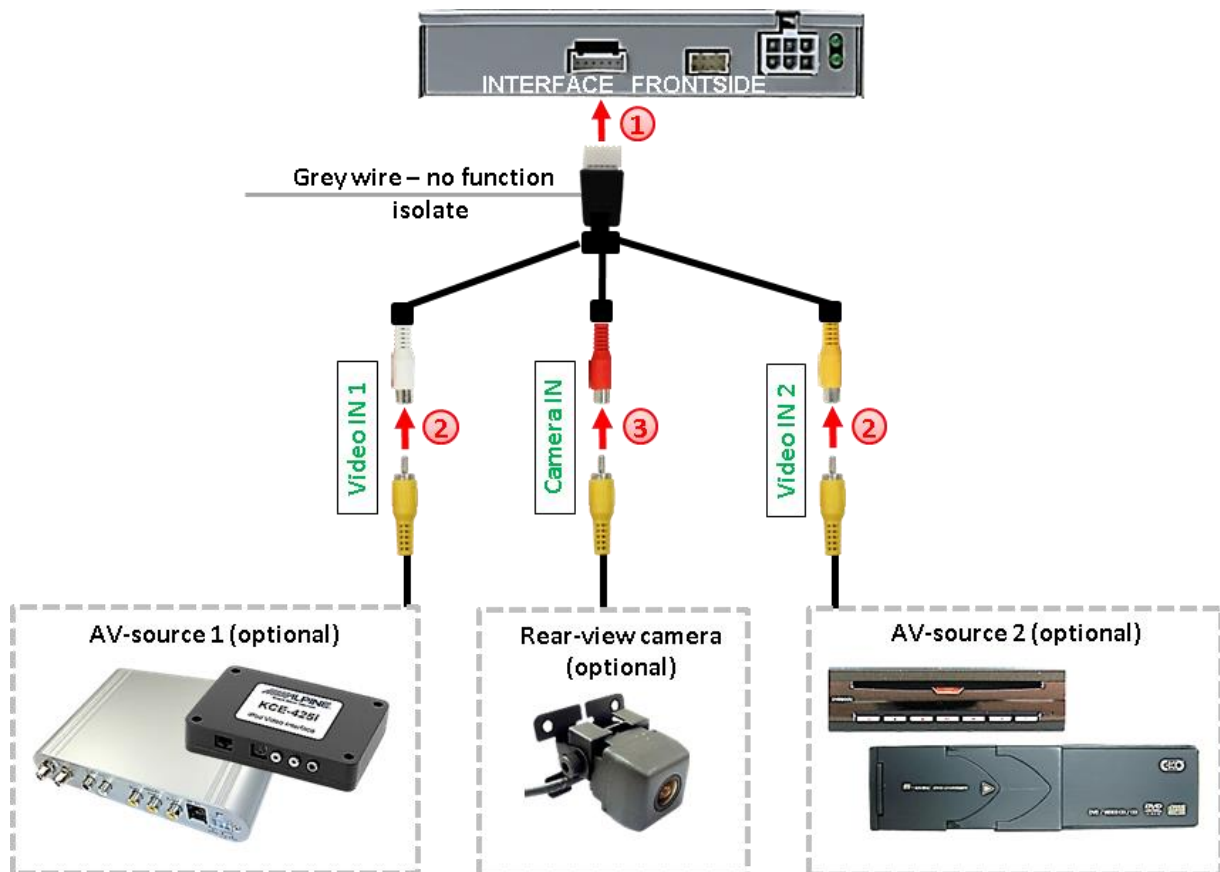

- 1 Connect the female 6pin connector of the video cable to the male 6pin connector of the video-interface.
- 2 Connect the video RCA of the video source 1 and 2 to the female RCA connector "Video IN1" and "Video IN 2" of the 6pin video cable.
- 3 Connect the video RCA of the rear-view camera to the female RCA connector "Camera IN" of the 6pin video cable.

### 2.6.1. Audio insertion

This interface can only insert video signals into the factory infotainment. Audio insertion must be done by factory audio AUX input or FM-modulator. The inserted video-signal can be activated simultaneously to each audio-mode of the factory infotainment. If 2 AV sources shall be connected to the infotainment, additional electronic is necessary to switch the audio signals.

### 2.6.2. After-market rear-view camera

Some vehicles have a different reverse gear code on the CAN-bus which the included CAN-box is not compatible with. Therefore, there are two different ways of installation. If the CAN-box detects the vehicle's reverse gear, the green wire of the 6pin to 8pin cable should carry +12V while the reverse gear is engaged.

**Note:** Do not forget to set dip5 of video-interface to ON before testing.

#### 2.6.2.1. Case 1: CAN-box detects reverse gear

If the CAN-bus interface delivers +12V on the green wire of the 6pin to 8pin cable when reverse gear is engaged, the video interface will automatically be switched to the rear-view camera input CAM while reverse gear is engaged.

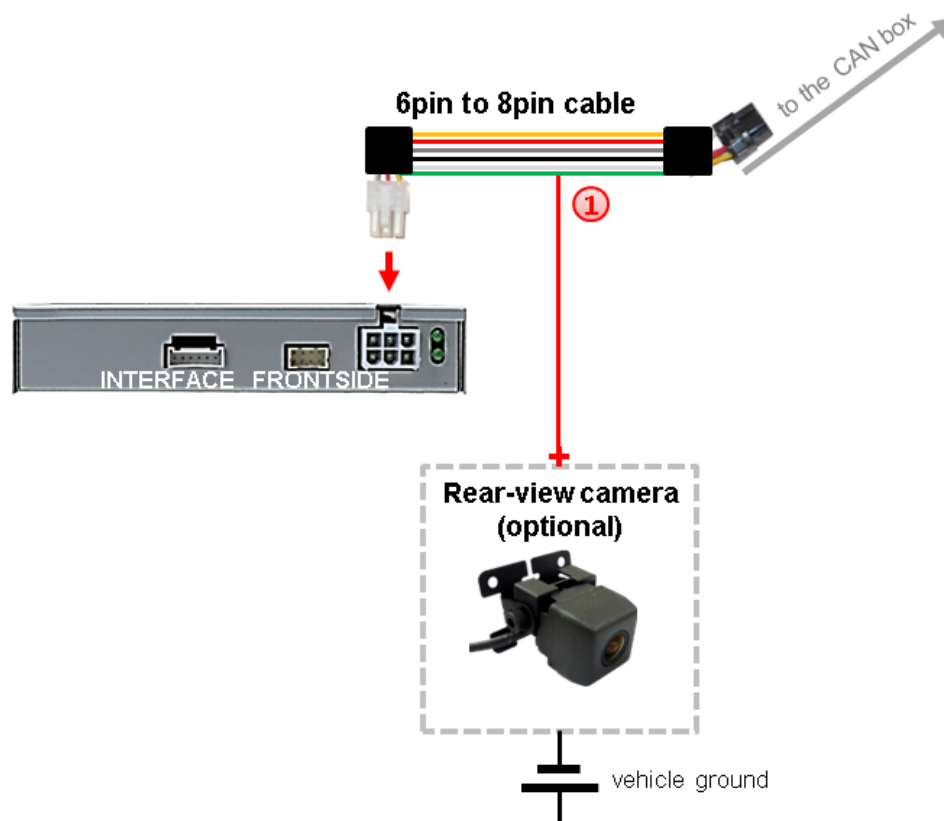

- ① Additionally, the +12V (max. 500mA) power supply for the rear-view camera can be taken from the green wire of the 6pin to 8pin cable.

### 2.6.2.2. Case 2: CAN-box does not detect reverse gear

If the CAN-bus interface does not deliver +12V on the green wire of the 6pin to 8pin cable when reverse gear is engaged (not all vehicles are compatible) an external switching signal from the reverse gear light is required. As the reverse gear light signal contains electronic interference, a normally open relay (e.g AC-RW-1230 with wiring AC-RS5) or filter (e.g. AC-PNF-RVC) is required. Below schema shows the use of a relay (normally open).

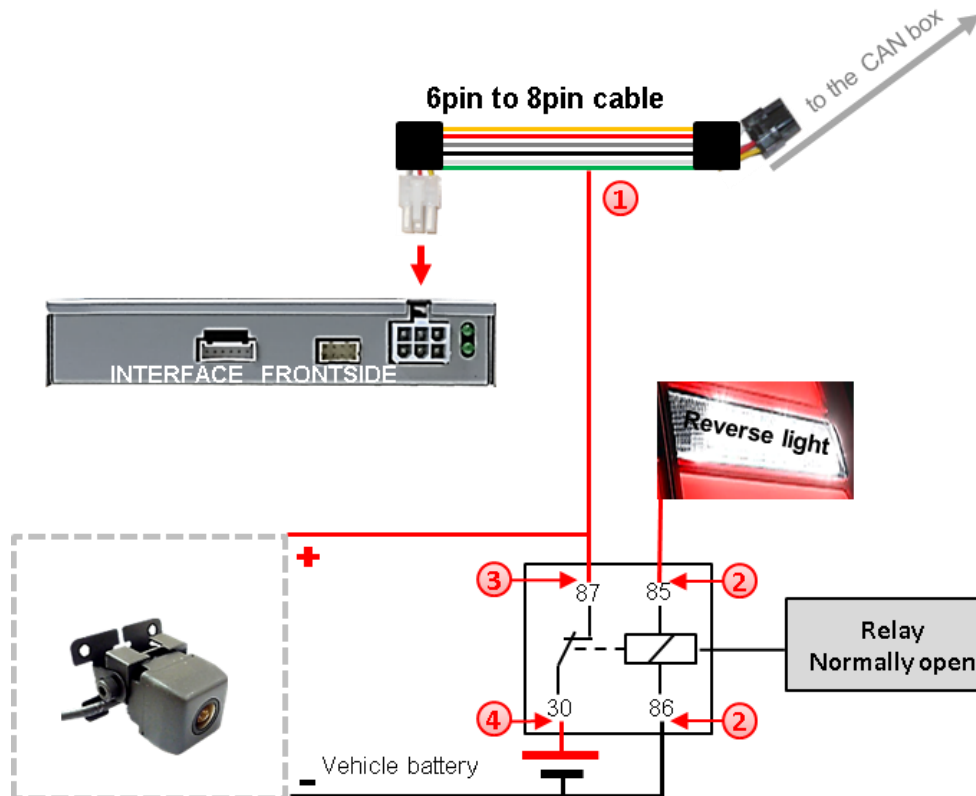

- 1 Connect the green wire of the 6pin to 8pin cable to the output connector (87) of the relay.
- 2 Connect the Reverse light's power-cable to coil (85) and the vehicle's ground to coil (86) of the relay.
- 3 Connect the output connector (87) of the relay to the rear-view camera's power-cable, like you did it to the green wire of the 6pin to 8pin cable before.
- 4 Connect stable and permanent +12V to the relay's input connector (30).

## 2.7. Connecting video-interface and keypad

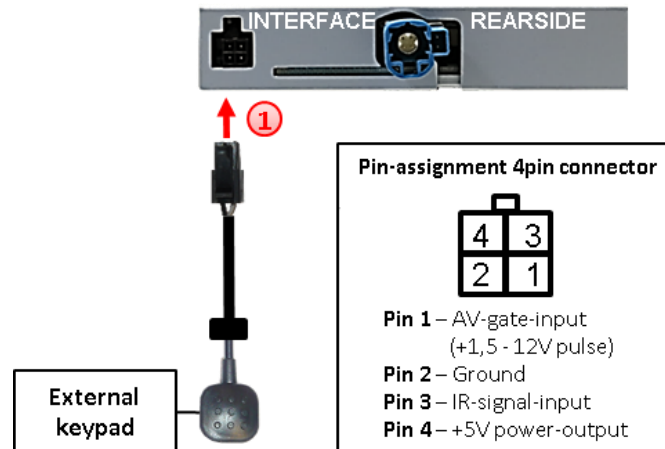

- 1 Connect the female 4pin connector of the keypad to the male 4pin connector of the video-interface.



2.8. Picture settings and guide lines

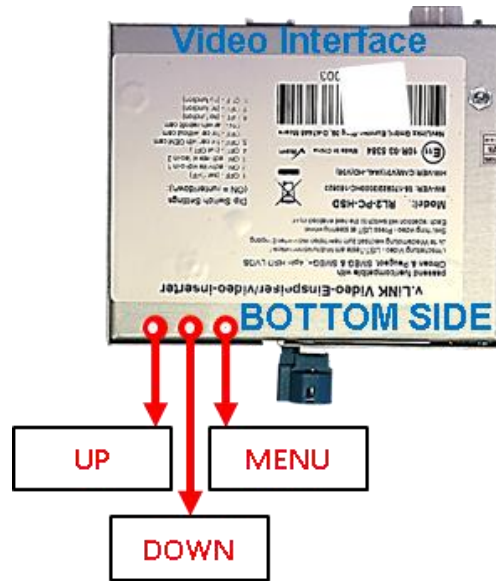

The picture settings are adjusted by the 3 buttons on the video-interface. Press the MENU button to open the OSD settings menu or to switch to the next menu item. Press UP and DOWN will change the selected value. The buttons are embedded in the housing to avoid accidental changes during or after installation. Picture settings must be done separately for AV1 and AV2 while the corresponding input is selected and visible on the monitor. The rear-view camera settings conceivably have to be done in AV 2.

**Note:** The OSD menu is only shown when a working video source is connected to the selected video-input of the interface.

The following settings are available:

- Contrast
- Brightness
- Saturation
- Position H (horizontal)
- Position V (vertical)
- Guide-CNTRL (guide lines ON/OFF)

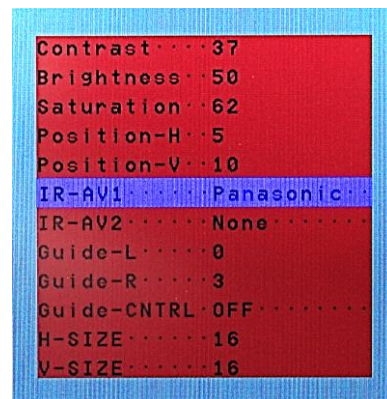

**Note:**

To adjust the reverse picture, engage the reverse gear.

To adjust the guide lines, move the steering wheel to see the changes.

If there is no communication between interface and the vehicle`s CAN-bus (several vehicles aren`t compatible), the reverse gear guide-lines can`t be shown during the vehicle`s operation, even if they once appear after having switched the system to powerless!

### 3. Interface operation

#### 3.1. By LIST-key

The LIST-key on the steering wheel is used to switch among all the inputs. The order is:

*Factory video → video AV1 → video AV2 → factory video →...*

Inputs which are not enabled are skipped.

**Switchover by vehicle buttons isn't possible in all vehicles. In some vehicles the external keypad has to be used.**

#### 3.2. By keypad

Alternatively or additionally to the factory infotainment buttons the interface's external keypad can be used to switch the enabled inputs.

### 4. Specifications video-interface

BATT/ACC range	7V - 25V
Stand-by power drain	40mA
Power	270mA
Video input	0.7V - 1V
Video input formats	PAL/NTSC
Temperature range	-40°C to +85°C
Dimensions video-box (W x H x D)	112 x 22 x 113 mm
Dimensions CAN-box (W x H x D)	89 x 27 x 65 mm

## 5. FAQ – Trouble shooting Interface functions

For any troubles which may occur, check the following table for a solution before requesting support from your vendor.

Symptom	Reason	Possible solution
No picture/black picture (factory picture).	Not all connectors have been reconnected to factory head-unit or monitor after installation.	Connect missing connectors.
	No power on CAN-bus box (all LED CAN-bus box are off).	Check power supply of CAN-bus box. Check CAN-bus connection of CAN-bus box.
	CAN-bus box connected to CAN-bus in wrong place.	Refer to the manual where to connected to the CAN-bus. If not mentioned, try another place to connect to the CAN-bus.
	No power on video-interface (all LED video-interface are off).	Check whether CAN-bus box delivers +12V ACC on red wire output of 8pin to 6pin cable. If not cut wire and supply ACC +12V directly to video-interface.
No picture/black picture/white picture (inserted picture) but factory picture is OK.	No picture from video source.	Check on other monitor whether video source is OK.
	No video-source connected to the selected interface input.	Check settings dips 1 to 3 of video interface which inputs are activated and switch to corresponding input(s).
	LVDS cables plugged in wrong place.	Double-check whether order of LVDS cables is exactly connected according to manual. Plugging into head-unit does not work when the manual says to plug into monitor and vice versa.
Inserted picture totally wrong size or position.	Wrong monitor settings of video-interface.	Try different combinations of dips 7 and 8 of video-interface. Unplug 6pin power after each change.
Inserted picture double or 4 times on monitor.		
Inserted picture distorted, flickering or running vertically.	Video sources output set to AUTO or MULTI which causes a conflict with the interfaces auto detection.	Set video source output fixed to PAL or NTSC. It is best to set all video sources to the same standard.
	If error occurs only after source switching: Connected sources are not set to the same TV standard.	Set all video sources to the same standard.
	Some interfaces can only handle NTSC input.	Check manual whether there is a limitation to NTSC mentioned. If yes, set source fixed to NTSC output.
Inserted picture b/w.	Picture settings have not been adjusted.	Use the 3 buttons and the interface's OSD to adjust the picture settings for the corresponding video input.
Inserted picture qual. bad.		
Inserted picture size slightly wrong.		
Inserted picture position wrong.	Camera is being tested under fluorescent light which shines directly into the camera.	Test camera under natural light outside the garage.
Camera input picture flickers.		
Camera input picture is bluish.	Protection sticker not removed from camera lens.	Remove protection sticker from lens.

Symptom	Reason	Possible solution
Camera input picture black.	Camera power taken directly from reverse gear lamp.	Use relay or electronics to "clean" reverse gear lamp power. Alternatively, if CAN-bus box is compatible with the vehicle, camera power can be taken from green wire of 6pin to 8pin cable.
Camera input picture has distortion.		
Camera input picture settings cannot be adjusted.	Camera input picture settings can only be adjusted in AV2 mode.	Set dip 3 of video-interface to ON (if not input AV2 is not already activated) and connect the camera to AV2. Switch to AV2 and adjust settings. Reconnect camera to camera input and deactivate AV2 if not used for other source.
Graphics of a car in camera input picture.	Function PDC is ON in the interface OSD.	In compatible vehicles, the graphics will display the factory PDC distance. If not working or not wanted, set interface OSD menu item UI-CNTRL to ALLOFF.
Chinese signs in camera input picture	Function RET or ALL is ON (function for Asian market) in the interface OSD.	Set interface OSD menu item UI-CNTRL to ALLOFF or PDCON.
Not possible to switch video sources by OEM button.	CAN-bus interface does not support this function for vehicle.	Use external keypad or cut white wire of 6pin to 8pin cable and apply +12V impulses for AV-switching.
Not possible to switch video sources by external keypad.	Pressed too short.	For video source switching a longer press of about 2.5 seconds is required.
	SW-version of interface does not support external keypad.	Use OEM-button or cut white wire of 6pin to 8pin cable and apply +12V impulses for AV-switching.
Interface does not switch to camera input when reverse gear is engaged.	CAN-bus interface does not support this function for the vehicles.	Cut the green wire of the 6pin to 8pin cable and apply +12V constant from reverse gear-lamp signal. Use relay to "clean" R-gear lamp power.
Interface switches video-sources by itself.	CAN-bus interface compatibility to vehicle is limited.	Cut the grey wire of 6pin to 8pin and isolate both ends. If problem still occurs, additionally cut the white wire of 6pin to 8pin cable and isolate both ends.

## 6. Technical Support

Please note that direct technical support is only available for products purchased directly from NavLinkz GmbH. For products bought from other sources, contact your vendor for technical support.

**NavLinkz GmbH**  
**distribution/tech dealer-support**  
 Eurotec-Ring 39  
 D-47445 Moers

Tel +49 2841 949970  
 Email mail@navlinkz.de

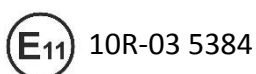

Made in China

