

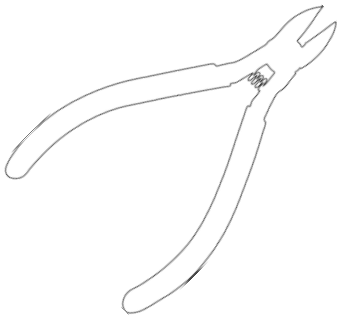

Tools

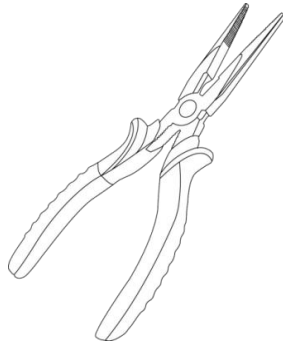

Diagonal pliers



Needle nose pliers

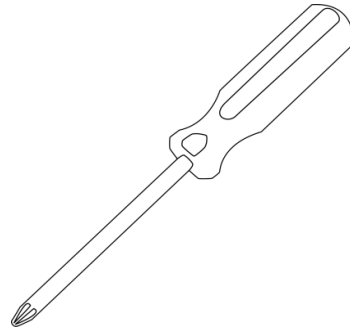

screwdriver

Assembly steps

Cut off the 4 holes of lamps bracket

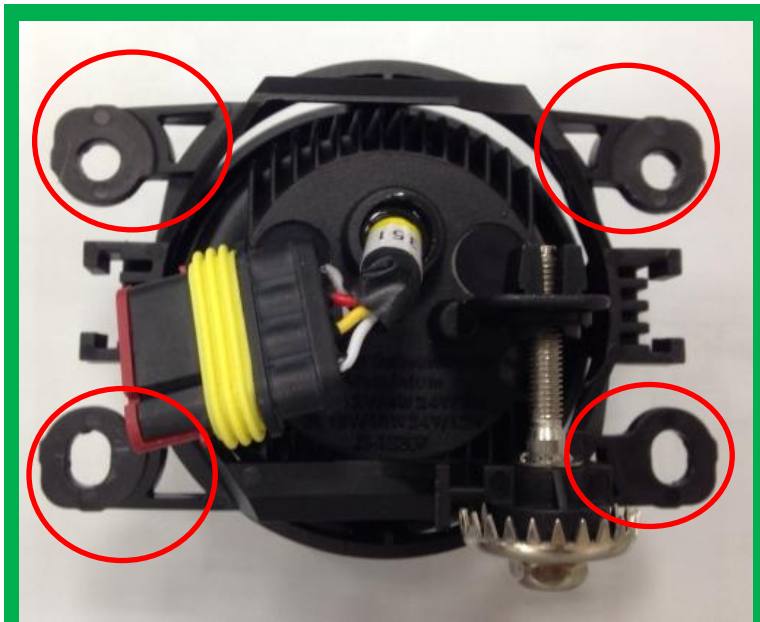

Combine the bracket and lamp, then outward bending the snaps

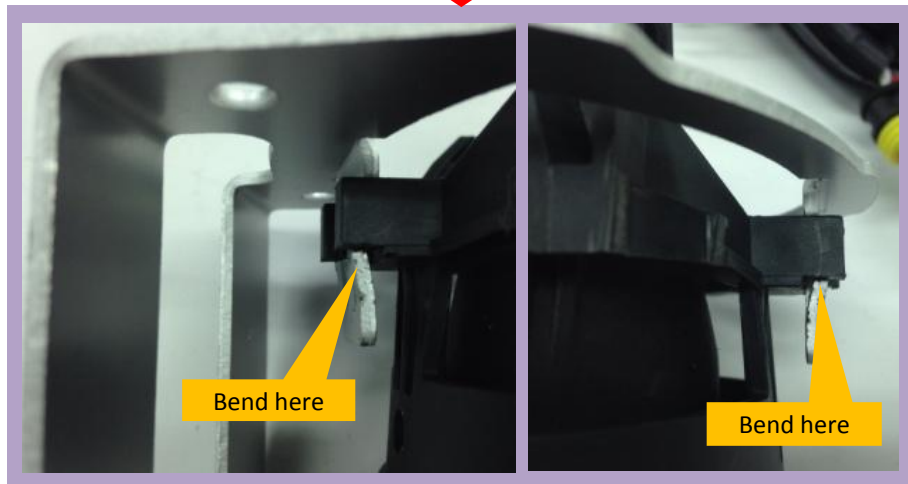
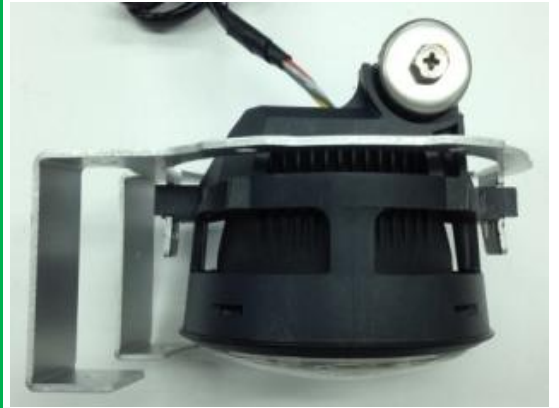
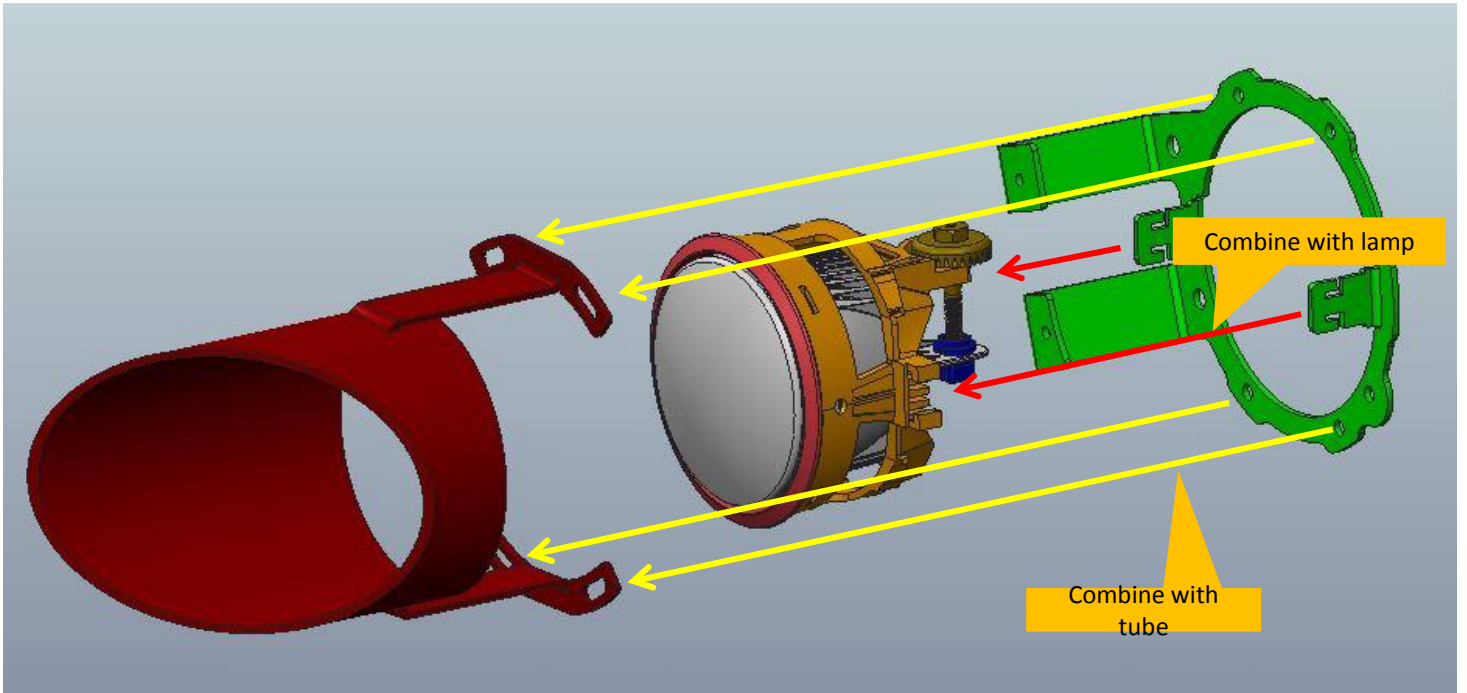

Combine tube, and fix the 4 screw holes

